



KLJUČEVI

Dugotrajan profil

Ključevi su izrađeni od Premium krom-vanadij čelika vrhunske kvalitete. Karakteristično je da je gustoća materijala najveća na mjestima koja trpe najveća opterećenja. Takvo dimenzioniranje i proizvodnja povećavaju ekstremnu snagu i dugotrajnost Uniorovih ključeva. Inovativan dizajn.

Sigurnosni rez

Specijalan sigurnosni rez, kojim su izrađeni ključevi, sprječava oštećenja uglova i rubova vijaka i matica ravnomjernom distribucijom sile po površini kontura matica i vijaka umjesto direktno na same rubove.

Inovativan dizajn

Unior ključevi svojim inovativnim dizajnom i vrhunskim performansama osiguravaju točnost i učinkovitost prijenosa sile na glave vijaka i matica.



Postupak proizvodnje viljuškasto-okastog ključa veličine 24

- Narez:** Strojno; ravna čelična ploča reže se u potreban oblik; preciznost reza omogućava minimalnu upotrebu kvalitetnog materijala.
- Kovanje:** Postupkom kovanja, izvedenom na poznatom LASCO strojevima, postiže se potrebna čvrstoća i žilavost viljuškasto-okastog ključa; primjenom posebnih tehnika kovanja održava se odgovarajuća orijentacija vlakana (istovjetna kao kod valjanih oblika), koja je od ključne važnosti za proizvode izložene teškim, dinamičkim opterećenjima.
- Obrezivanje:** Odstranjivanje viška materijala oko otkivka, nastalog kovanjem u kalupima, izvodi se posebnim alatom za obrezivanje. Obrezivanje svih viškova materijala do željenog oblika alata vrši se tako da je težina obrezanih dijelova manja od težine samog otkivka.
- Probijanje:** Nakon kovanja i obrezivanja, probijanje se izvodi na radnom komadu probijanjem i rezanjem. Ovi postupci se mogu izvesti bilo na hladnom bilo na toplom radnom predmetu.
- Ravnanje rubova i brušenje:** U posebnim bubnjevima, pomoću mehaničkih i kemijskih sredstava, odstranjuju se i ujednačavaju grubi rubovi na otkivku, nakon čega se ključevi postavljaju na strojeve za brušenje za konturno brušenje rubova alata. Tim postupkom se postiže glatkoća i zaobljenost površina rubova ključa.
- Strojno obilježavanje i savijanje:** U skladu s postavljenim standardima, u svaki proizvod je utisnuta odgovarajuća oznaka; nakon toga, prstenasti (okasti) dio ključa savija se pod određenim kutom po posebnim zahtjevima.
- Oblikovanje:** U oblikovanju, materijal se odstranjuje jednim potezom uzastopnih, višestrukih oštrica na samom provlakaču. U proizvodnji Unior ključeva, unutrašnji profil obruča (prstena) ključa izrađuje se korištenjem MAE stroja za oblikovanje.
- Termička obrada:** Kaljenjem i otpuštanjem poboljšava se struktura čelika i postižu se veće tvrdoće ključa na željenim mjestima; termička obrada garancija je dugog vijeka trajanja Unior ključeva i otpornosti na velika opterećenja i pritiske.
- Brušenje:** Pomoću komprimiranog zraka, na površinu ključeva nanose se različita abrazivna sredstva, koja čiste površinu alata i ujedno ostvaruju potrebnu hrapavost za nanošenje odgovarajućeg galvanskog (zaštitnog) sloja. U određenim varijantama, površine glave ključa su polirane radi boljeg konačnog izgleda ključa.
- Kromiranje i poliranje:** Ključevi se oblažu tankim, ali dovoljno čvrstim slojem from-dioksida radi zaštite od korozije, habanja i drugih mehaničkih oštećenja; metal krom se koristi za legiranje čelika i za oblaganje metala, čime se pored zaštite ključevima daje atraktivan vizuelni sjaj.

10 najvažnijih koraka od 24

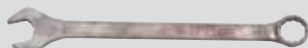

Premium

Premium krom vanadij čelik

Vrhunska pouzdanost

Za alate, kao što su ključevi i obujmice za crijeva, koji moraju podnijeti veće opterećenje, posebno su važni odgovarajuća žilavost materijala s većom elastičnošću i malom osjetljivošću na pukotine. Te zahtjeve savršeno zadovoljava Premium krom vanadij čelik, legirani alatni čelik s manganom, kromom, silicijem i ugljikom. Alati izrađeni od ovog čelika imaju dugi vijek trajanja i savršeni su izbor za dugotrajnu uporabu.

Legirani alatni čelik 31CrV3, sukladan EuroDirective 2000/53/EC

- 0,60% mangana za veću tvrdoću i veću čvrstoću vlakana
- 0,60% kroma za smanjivanje osjetljivosti na pukotine i veće čvrstoće vlakana
- 0,30% silicija za veću elastičnost
- 0,35% ugljika za odgovarajuću tvrdoću alata

KLJUČ VILJUŠKASTI	21 - 23
Ključevi podešavajući	23 - 24
Ključevi viljuškasto-okasti	24 - 27
Okasti ključevi	27 - 29
Ključevi s računom	29 - 31
Ključevi udarni	32
Kukasti ključevi	32 - 33
Nasadni ključevi	33 - 36
Cijevni ključevi	36 - 37
Imbus ključevi	37 - 43

Usporedba zakretnog momenta 110/1 Viljuškasti ključevi

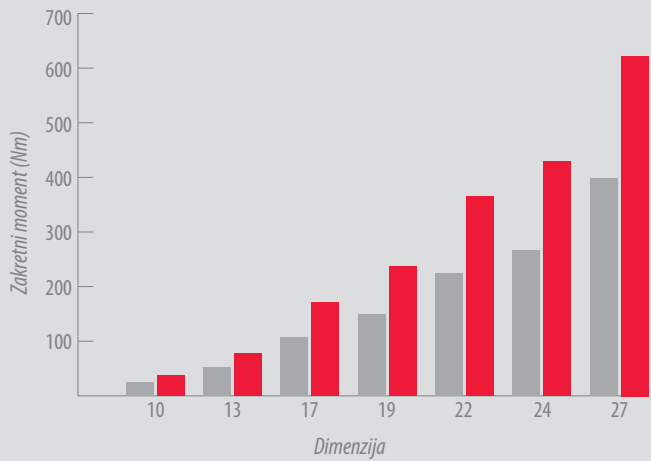

Usporedba zakretnog momenta 180/1 Okasti ključevi

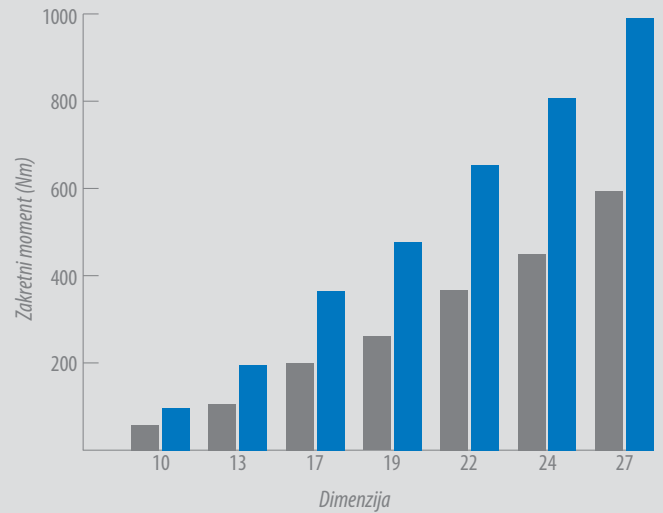

Usporedba zakretnog momenta 120/1 Ključ viljuškasto-okasti, dugi

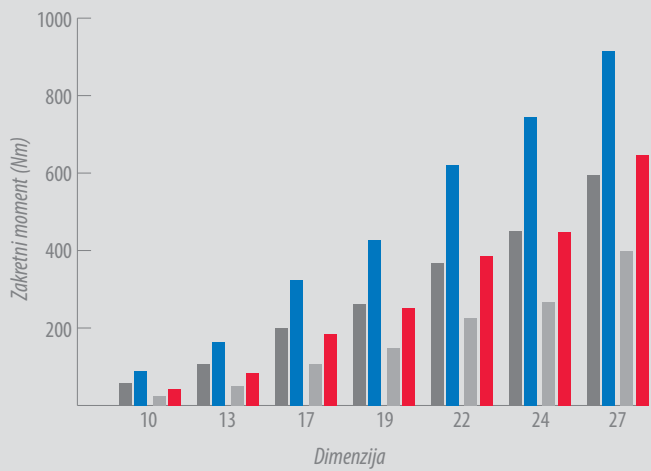

■ ISO 1711-1 (A) okasti dio
■ UNIOR viljuškasti dio
■ ISO 1711-1 (C) viljuškasti dio
■ UNIOR okasti dio
 ISO i UNIOR u Nm

LIFE profil

Glavne prednosti LIFE profila

- Prihvata površinu zavrtnja i matica u samo 6 točaka
- Štiti rubove vijaka i matica
- Brže pozicioniranje alata i udoban rad
- Pogodan i za oštećene vijke i maticе

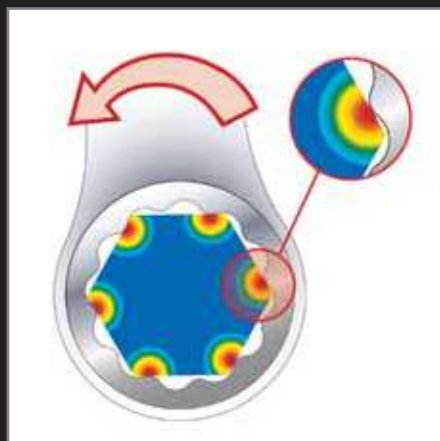

110/1

Ključ viljuškasti

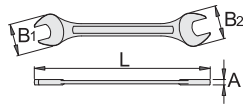

- Materijal: Premium krom-vanadij
- Kovan, u cjelosti ojačan i zakaljen
- Kromirani (EN 12540)
- Polirane glave
- Izrađeni prema standardu ISO10102 (samo metričke dimenzije)
- glava ključa pod kutom 15°



Barcode	⊕	L	B1	B2	A	👤	🔧	📏
603316	4 x 4.5	100	14	14	3.4	10	4A	10
603317	4 x 5	100	14	14	3.4	10	4A	10
603318	5 x 5.5	100	14	14	3.4	10	4A	10
600060	5.5 x 7	121	14.4	16.4	3.4	15	4A	10
600061	6 x 7	121	14.4	16.4	3.4	15	4A	10
600062	7 x 8	140	18.4	22.9	3.7	24	4A	10
600064	8 x 9	140	18.4	22.9	3.7	24	4A	10
600065	8 x 10	140	18.4	22.9	3.7	23	4A	10
600066	9 x 10	159	22.7	24.2	4.5	43	4A	10
600067	9 x 11	159	22.7	24.2	4.5	40	4A	10
600068	10 x 11	159	22.7	24.2	4.5	40	4A	10
600069	10 x 12	172	26.2	29.2	4.9	58	4A	10
600070	10 x 13	172	26.2	29.2	4.9	59	4A	10
600072	11 x 13	172	26.2	29.2	4.9	58	4A	10
600074	12 x 13	172	26.2	29.2	4.9	58	4A	10
600075	12 x 14	172	26.2	29.2	4.9	58	4A	10
600076	13 x 14	192	31.2	33.2	5.4	81	4A	10
600077	13 x 15	192	31.2	33.2	5.4	84	4A	10
600078	13 x 17	200	31.2	37.7	5.7	101	4A	10
600079	14 x 15	192	31.2	33.2	5.4	83	4A	10
600080	14 x 17	200	31.2	37.7	5.7	101	4A	10
600081	15 x 17	206	35.7	37.7	5.7	108	4A	10
600082	16 x 17	206	35.7	37.7	5.7	108	4A	10
600083	17 x 19	223	39.5	41.5	6.2	143	4A	10
600084	17 x 22	232	43.5	46	6.2	193	4A	10
600085	18 x 19	223	39.5	41.5	6.2	148	4A	10
600086	19 x 22	232	43.5	46	6.7	183	4A	10
600088	20 x 22	232	43.5	46	6.7	180	4A	10
600089	21 x 23	249	46	52	7.2	235	4A	5
600090	22 x 24	249	46	52	7.2	237	4A	5
600091	22 x 27	265	51.8	55.3	7.2	301	4A	5
600092	24 x 26	265	51.8	55.3	7.7	289	4A	5
600093	24 x 27	265	53.8	51.8	7.7	289	4A	5
600095	25 x 28	279	62.8	53.8	8.2	344	4A	5
600096	27 x 29	309	62.8	67.3	9.2	535	4A	5
600097	27 x 30	309	62.8	67.3	9.2	527	4A	5
600098	27 x 32	309	62.8	67.3	9.2	541	4A	5
600099	30 x 32	309	62.8	67.3	9.2	532	4A	5
603848	30 x 34	315	62.8	68.8	9.6	568	1C	5
602593	30 x 36	319	62.8	78.8	9.6	591	1C	1

Barcode	⊕	L	B1	B2	A	👤	🔧	📏
600100	32 x 36	327	68.8	78.8	9.6	653	1C	1
600101	34 x 36	327	68.8	78.8	9.6	628	1C	1
600102	36 x 41	360	78.8	86.8	9.6	823	1C	1
605549	38 x 42	360	78.8	86.8	9.6	822	1C	1
602594	41 x 46	410	86.8	94.8	14.6	1735	1C	1
602595	46 x 50	460	94.8	103.9	15.6	2365	1C	1
605348	1/4"x5/16"	121	14.4	16.4	3.4	15	4A	10
618658	1/4"x9/32"	121	14.4	16.4	3.4	15	4A	10
605349	5/16"x3/8"	140	18.4	22.9	3.7	24	4A	10
618656	11/32"x13/32"	159	22.7	24.2	4.5	43	4A	10
605350	3/8"x7/16"	159	22.7	24.2	4.5	40	4A	10
605351	7/16"x1/2"	172	26.3	29.2	4.9	58	4A	10
605352	1/2"x9/16"	192	31.2	33.2	5.4	81	4A	10
605353	9/16"x5/8"	192	31.2	33.2	5.4	83	4A	10
605354	5/8"x11/16"	206	35.7	37.7	5.7	108	4A	10
605355	11/16"x3/4"	223	39.5	41.5	6.2	143	4A	10
605356	13/16"x7/8"	249	46	52	7.2	237	4A	5
605357	15/16"x1"	265	51.8	55.3	7.7	301	4A	5
605358	1"x1.1/8"	279	53.8	58.8	8.2	344	4A	5
605359	1.1/16"x1.1/4"	309	62.8	67.3	9.2	527	4A	5

110/1CB

Garnitura viljuškastih ključeva u kartonskoj ambalaži



Barcode	👤	👤	🔧	📏
600105	6 - 22 / 8	724	1F	1

🔧 110/1 (6 x 7, 8 x 9, 10 x 11, 12 x 13, 14 x 15, 16 x 17, 18 x 19, 20 x 22)

110/1CB

Garnitura viljuškastih ključeva u kartonskoj ambalaži



Barcode	👤	👤	🔧	📏
600106	6 - 32 / 12	2140	1F	1

🔧 110/1 (6 x 7, 8 x 9, 10 x 11, 12 x 13, 14 x 15, 16 x 17, 18 x 19, 20 x 22, 21 x 23, 24 x 26, 25 x 28, 27 x 32)

110/1CB

Garnitura viljuškastih ključeva u kartonskoj ambalaži



Barcode	👤	👤	🔧	📏
600107	6 - 41 / 13	3982	1F	1

🔧 110/1 (6 x 7, 8 x 9, 10 x 11, 12 x 13, 14 x 15, 16 x 17, 18 x 19, 20 x 22, 21 x 23, 24 x 26, 25 x 28, 27 x 32, 36 x 41)

110/1CB

Garnitura viljuškastih ključeva u kartonskoj ambalaži



Barcode	👤	👤	🔧	📏
611018	6 - 27 / 10	1250	1F	1

🔧 110/1 (6 x 7, 8 x 9, 10 x 11, 12 x 13, 14 x 15, 16 x 17, 18 x 19, 20 x 22, 21 x 23, 24 x 27)

110/1CB

Garnitura viljuškastih ključeva u kartonskoj ambalaži



Barcode	👤	👤	🔧	📏
605531	1/4" - 1.1/4" / 12	2005	1F	1

🔧 110/1 (1/4" x 5/16", 5/16" x 3/8", 3/8" x 7/16", 7/16" x 1/2", 1/2" x 9/16", 9/16" x 5/8", 5/8" x 11/16", 11/16" x 3/4", 13/16" x 7/8", 15/16" x 1", 1" x 1.1/8", 1.1/16" x 1.1/4")

110/1CS

Garnitura viljuškastih ključeva u kartonskoj ambalaži



Barcode	👤	👤	🔧	📏
602844	6 - 22 / 8	800	1G	1

🔧 110/1 (6 x 7, 8 x 9, 10 x 11, 12 x 13, 14 x 15, 16 x 17, 18 x 19, 20 x 22)

110/1CT

Ključevi viljuškasti u torbici



Barcode	👤	👤	🔧	📏
615465	6 - 22 / 8	788	1T	1

🔧 110/1 (6 x 7, 8 x 9, 10 x 11, 12 x 13, 14 x 15, 16 x 17, 18 x 19, 20 x 22), CT110



CT110

Torbica, prazna



- Dimenzije 430x275, za art. 110 i 125
- Čičak traka za lako otvaranje i zatvaranje
- Nije potreban remen za zatvaranje
- materijal: poliestersko platno

Barcode	A x B	Weight	Material	Quantity
615480	430 x 275	117	TE	1

110/1PB

Garnitura viljuškastih ključeva u plastičnom etuiu



Barcode	Hand	Weight	Material	Quantity
600108	6 - 17 / 6	378	TE	1

110/1 (6x7, 8x9, 10x11, 12x13, 14x15, 16x17)

110/1PB

Garnitura viljuškastih ključeva u plastičnom etuiu

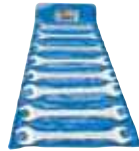

Barcode	Hand	Weight	Material	Quantity
600109	6 - 22 / 8	747	TE	1

110/1 (6 x 7, 8 x 9, 10 x 11, 12 x 13, 14 x 15, 16 x 17, 18 x 19, 20 x 22)

110/1PH

Garnitura viljuškastih ključeva na plastičnom stalku



Barcode	Hand	Weight	Material	Quantity
610835	6 - 22 / 8	885	TF	1

110/1 (6 x 7, 8 x 9, 10 x 11, 12 x 13, 14 x 15, 16 x 17, 18 x 19, 20 x 22)



110/1MS

Garnitura viljuškastih ključeva na metalnom stalku



Barcode	Hand	Weight	Material	Quantity
605528	6 - 32 / 12	2740	TF	1

110/1 (6 x 7, 8 x 9, 10 x 11, 12 x 13, 14 x 15, 16 x 17, 18 x 19, 20 x 22, 21 x 23, 24 x 26, 25 x 28, 27 x 32), 977/1 (6 - 32/12)

110/1MS

Garnitura viljuškastih ključeva na metalnom stalku



Barcode	Hand	Weight	Material	Quantity
605532	1/4" - 1.1/4" / 12	2642	TF	1

110/1 (1/4" x 5/16", 5/16" x 3/8", 3/8" x 7/16", 7/16" x 1/2", 1/2" x 9/16", 9/16" x 5/8", 5/8" x 11/16", 11/16" x 3/4", 13/16" x 7/8", 15/16" x 1", 1" x 1.1/8", 1.1/16" x 1.1/4"), 977/1 (6 - 32/12)

112/2

Ključ viljuškasti

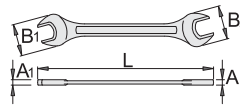

- Materijal: Premium alatni čelik
- Kovan, u cijelosti ojačan i zakaljen
- Kromirani (ISO 1456:2009)
- izrađen prema standardu DIN 895

Barcode	Hand	L	B1	B2	A1	A2	Weight	Material	Quantity
602082	8 x 10	115	18	22	4.2	4.2	20	4A	10
613222	10 x 11	122	23	24.5	5	5	35	4A	10
605045	10 x 12	128	22	28	5	5	37	4A	10
603611	10 x 13	137	26	28.5	5.2	5.2	43	4A	10
602083	11 x 13	132	26	28.5	5	5.4	41	4A	10
602084	12 x 14	146	28	32	5.5	5.5	52	4A	10
602085	13 x 15	152	28	32	6	6	63	4A	10
603134	13 x 17	158	30	35	6.5	6.5	65	4A	10
612774	14 x 15	137	26	28.5	5.4	5.4	51	4A	10
602086	14 x 17	158	30	35	6.5	6.5	62	4A	10
602087	17 x 19	170	35	40	7	7	94	4A	10
602088	19 x 22	197	42	48	8	8	138	4A	10

114/2

Ključ viljuškasti, dvostrani, mali ELECTRIC

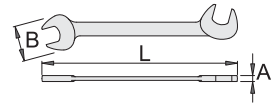

- Materijal: Premium poseban alatni čelik
- U cijelosti ojačan i zakaljen
- Kromirani (EN 12540)

Barcode	Hand	L	B	A	Weight	Material	Quantity
618623	3.2	75	10	2	2	4A	10
618624	3.5	75	10	2	2	4A	10
618625	4	75	10.5	2	2	4A	10
618626	4.5	75	10.5	2	2	4A	10
618627	5	85	12	2	4	4A	10
618628	5.5	85	12.2	2	4	4A	10
618629	6	85	12.5	2	4	4A	10
618630	7	95	14.5	2	6	4A	10
618631	8	95	16.5	2	7	4A	10
618632	9	110	19	3	17	4A	10
618633	10	110	21	3	18	4A	10
618634	11	110	23.5	3	20	4A	10
618635	12	125	24	3	30	4A	10
618636	13	125	27.5	3	33	4A	10
618637	14	125	28	3	33	4A	10
618639	16	135	32	3	39	4A	10
618641	7/32"	85	12.2	2	4	4A	10
618643	9/32"	95	14.5	2	6	4A	10
618642	11/32"	110	19	3	17	4A	10

114/2PB

Ključevi viljuškasti, mali, za električare u plastičnom etuiu



Barcode	Hand	Weight	Material	Quantity
619287	3.2 - 14 / 15	292	TE	1

114/2 (3.2, 3.5, 4, 4.5, 5, 5.5, 6, 7, 8, 9, 10, 11, 12, 13, 14)



250/1

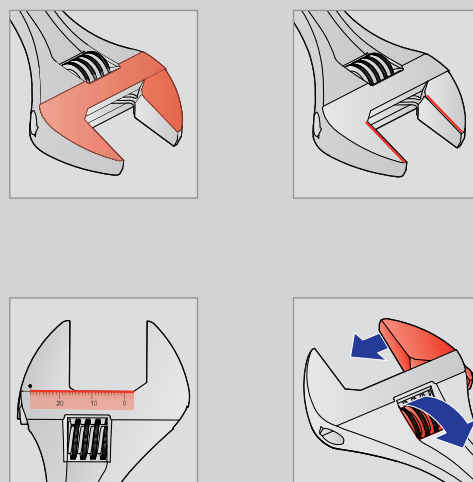

117/4

Ključ viljuškasti, jednostrani

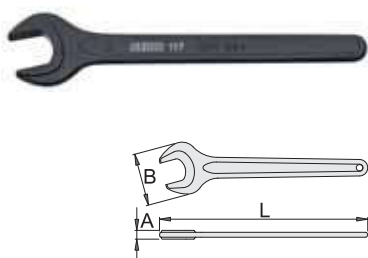

- Materijal: Premium krom vanadij
- Kovan, u cijelosti ojačan i zakaljen
- Završna obrada: fosfatiranje po standardu DIN12476
- Izrađeni prema standardu DIN 894

Upotreba

- Područje primjene: u industriji, u radu sa strojevima, motorima i drugom opremom.
- Veće dimenzije su neophodne u brodogradnji, naftnoj industriji i teškoj industriji gdje se izvode zahvati na velikim strojevima i opremi.
- Ključ je posebno koristan pri radu koji zahtjeva veću silu zatezanja i dužu polugu na teško dostupnim mjestima.



Barcode	⊕	L	A	B	⊞	⚙	⚙
615262	10	104	4,5	22	21	4A	10
620207	12	123	5	26	29	4A	10
615263	13	132	5,4	28	35	4A	10
615264	17	157	6,5	36	68	4A	10
615265	19	170	6,9	40	78	4A	10
615266	21	195	7,9	46	98	4A	10
615267	22	195	7,9	46	106	4A	10
615268	24	218	9,2	50	147	4A	5
615269	27	240	9,7	56	192	4A	5
615270	30	267	11,1	63	297	4A	5



Barcode	⊕	L	A	B	⊞	⚙	⚙
615271	32	267	11,7	66	297	4A	5
615272	34	295	12,5	74	399	1C	1
615273	36	295	12,5	74	438	1C	1
615274	38	295	12,5	74	390	1C	1
615275	41	335	13,5	84	537	1C	1
615276	46	365	14,5	94	747	1C	1
615277	50	400	15,5	102	890	1C	1
615278	55	475	16	110	1170	1C	1
615279	60	475	17	120	1365	1C	1
615280	65	550	18	130	1665	1C	1
615281	70	550	19	140	1995	1C	1
615282	75	620	20	150	2995	1C	1
615283	80	665	21	160	3895	1C	1

135/2

Ključ jednostrani za plinske boce

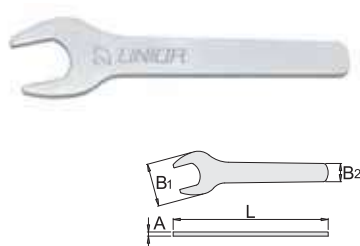

- Materijal: Premium lim
- Kromirani (ISO 1456:2009)

Barcode	⊕	L	B1	B2	A	⊞	⚙	
600262	27	187	52	22	4	149	4A	10

250/1

Ključ podešavajući

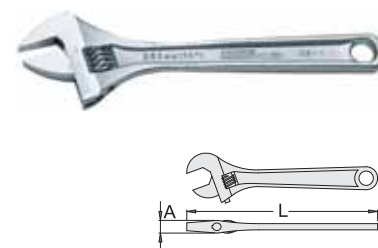

- Materijal: Premium krom-vanadij
- Kovan, u cijelosti ojačan i zakaljen
- kromirani (ISO 1456:2009)
- Polirane glave
- Sa mjernom skalom
- Izrađen prema standardu ISO 6787

Barcode	↖	L	A	⊕	⊞	⚙	⚙
611917	100	110	9,8	17	61	4A	10
611918	150	155,5	11,5	23	133	4A	10
601016	200	205	12,6	28	243	4A	10
601017	250	254	16	32	439	4A	10
601018	300	305	19	38	702	1C	10
601019	380	380	25	50	1315	1C	5
605113	450	458	26,3	60	1730	1C	1
615148	600	610	30	70	3240	1C	1



250/1ADP

Ključ podešavajući

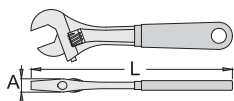

- Materijal: Premium krom-vanadij
- Kovan, u cijelosti ojačan i zakaljen
- Kromirani (ISO 1456:2009)
- Polirane glave
- Sa mjernom skalom
- Ručke obložene duplim slojem plastike
- Izrađen prema standardu ISO 6787

Barcode	L	A	⊕	⊖	⊞	⊟
617246	200	205	17	28	280	4A 10
617247	250	255	19	32	490	4A 10
617248	300	305	23,5	38	785	1C 10
617249	380	385	24	50	1395	1C 5

250/1ST250

Ključevi podešavajući na kartonskom stalku



Barcode	⊞	⊟	⊞	⊟
623909	6	3122	1F	

250/1 (250)

251/4

Ključ podešavajući

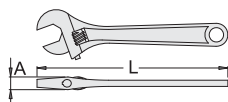

- materijal: Premium krom-vanadij
- Kovan, u cijelosti ojačan i zakaljen
- Završna obrada: fosfatiranje po standardu DIN12476
- Lijevi navoj
- Sa mjernom skalom
- Izrađen prema standardu ISO 6787

Barcode	L	A	⊕	⊖	⊞	⊟
612870	150	155.7	11.7	20	137	4A 10
612871	200	204.3	14.4	25	257	4A 10
612872	250	254	16.9	30	447	4A 10
612873	300	303.5	19.1	36	700	1C 10

120/1

Ključ viljuškasto-okasti, dugi

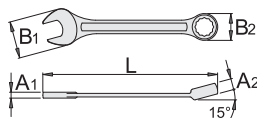

- Materijal: Premium krom-vanadij
- Kovan, u cijelosti ojačan i zakaljen
- kromirani (ISO 1456:2009)
- Polirane glave
- Obuhvatni dio sa LIFE profilom
- Izrađeni prema standardu ISO 7738 (samo metričke dimenzije)



Barcode	⊕	L	B2	B1	A2	A1	⊞	⊟	
616745		3.2	105	8	14	4	3.2	11	4A 10
616746		4	105	8	14	4	3.2	11	4A 10
616747		4.5	105	8	14	4	3.2	7	4A 10
616748		5	119	10.4	14.5	5	3.5	7	4A 10
616749		5.5	119	10.4	14.5	5	3.5	15	4A 10
600357		6	119	10.4	14.5	5	3.5	14	4A 10
600358		7	129	11.5	16.5	5.8	3.9	15	4A 10
600359		8	141	13.2	18.5	6.9	3.9	23	4A 10
600360		9	152	14.3	21	7.3	4	27	4A 10
600361		10	163	15.9	23	7.5	4.2	37	4A 10
600362		11	176	17.8	24.5	8	4.5	45	4A 10
600363		12	186	19.4	26.5	8.5	4.7	55	4A 10
600364		13	199	20.4	29.5	8.5	5.2	68	4A 10
600365		14	210	22	31.5	9	5.2	82	4A 10
600366		15	222	23.2	33.5	9.5	5.7	96	4A 10
600367		16	234	24.8	36	10.5	6.2	121	4A 10
600368		17	245	26.1	38	10.5	6.7	144	4A 10
600369		18	257	27.7	40	11	7.2	165	4A 10
600370		19	268	29.3	42	12	7.2	186	4A 10
600371		20	280	31	44	12.5	7.7	225	4A 10
600372		21	291	32.6	45.5	13	8.2	251	4A 10
600373		22	303	34.1	46.5	13	8.2	266	4A 10
600374		23	314	35.7	50.5	13	8.2	300	4A 5
600375		24	330	37.3	52.5	14	8.5	382	4A 5
600376		25	337	39	54.5	14.5	8.5	377	4A 5
600377		26	349	40.1	56	15	8.5	422	4A 5
600378		27	360	41.6	57.5	15	9	453	4A 5
600379		28	373	43.2	59.5	15.5	9	532	4A 5
600380		29	383	44.9	61.5	16	9.5	567	4A 5
600381		30	395	46.5	63.5	16	10	632	4A 5
600382		32	416	49	68	16.5	10.5	719	4A 5
607019		35	500	53.5	78.8	20	13.6	1405	1C 1
602601		36	500	53.5	78.8	20	13.6	1415	1C 1
605838		38	515	58	82.8	20.5	14.1	1310	1C 1
602602		41	540	62	86.8	21	14.6	2025	1C 1
618514		46	560	69	94	23	16	2445	1C 1
618517		50	580	75	103	24	17	1955	1C 1
616752		55	600	83	112	26	18	3395	1C 1

Barcode	⊕	L	B2	B1	A2	A1	⊞	⊟	
616753		60	620	91	120	28	20	4120	1C 1
616754		65	640	100	130	30	21	5205	1C 1
616755		70	660	108	140	32	23	5995	1C 1
616756		75	680	116	150	34	24	6995	1C 1
616757		80	700	124	160	36	26	8595	1C 1
618491		1/4"	119	10.4	14.5	5	3.5	14	4A 10
618492		5/16"	142	13.2	18.5	6.9	3.9	23	4A 10
618493		3/8"	153	14.3	21	7.3	4	27	4A 10
618494		7/16"	176	17.8	24.5	8	4.5	45	4A 10
618495		1/2"	199	20.4	29.5	8.5	5.2	68	4A 10
618496		9/16"	211	22	31.5	9	5.2	82	4A 10
618497		5/8"	234	24.8	36	10.5	6.2	121	4A 10
618498		11/16"	245	26.1	38	10.5	6.7	144	4A 10
618499		3/4"	268	29.3	42	12	7.2	186	4A 10
618500		13/16"	291	32.6	45.5	13	8.2	251	4A 10
618501		7/8"	303	34.1	46.5	13	8.2	266	4A 10
618502		15/16"	330	37.3	52.5	14	8.5	382	4A 5
618503		1"	337	39	54.5	14.5	8.5	377	4A 5
618504		1.1/16"	360	41.6	57.5	15	9	453	4A 5
618505		1.1/8"	372	43.2	59.5	15.5	9	532	4A 5
618506		1.1/4"	417	49	68	16.5	10.5	719	4A 5
618507		1.5/16"	417	49	68	16.5	10.5	732	1C 5
618508		1.3/8"	500	53.5	78.8	20	13.6	1425	1C 1
618509		1.7/16"	500	53.5	78.8	20	13.6	1395	1C 1
618510		1.1/2"	500	53.5	78.8	20	13.6	1335	1C 1
618511		1.5/8"	540	62	86.8	21	14.6	1975	1C 1
618512		1.11/16"	540	62	86.8	21	14.6	1995	1C 1
618513		1.3/4"	560	69	94	23	16	2435	1C 1
618515		1.13/16"	560	69	94	23	16	2495	1C 1
618516		1.7/8"	560	69	94	23	16	2445	1C 1
618518		2"	580	75	103	24	17	2985	1C 1

120/1CB

Garnitura dugih viljuškasto-okastih ključeva u kartonskoj ambalaži



Barcode	⊞	⊟	⊞	⊟
600383	6 - 22 / 17	1930	1F	1

120/1 (6, 7, 8, 9, 10, 11, 12, 13, 14, 15, 16, 17, 18, 19, 20, 21, 22)

120/1CB

Garnitura dugih viljuškasto-okastih ključeva u kartonskoj ambalaži



Barcode	⊞	⊟	⊞	⊟
600384	6 - 32 / 26	6200	1F	1

120/1 (6, 7, 8, 9, 10, 11, 12, 13, 14, 15, 16, 17, 18, 19, 20, 21, 22, 23, 24, 25, 26, 27, 28, 29, 30, 32)

120/1CB

Garnitura dugih viljuškasto-okastih ključeva u kartonskoj ambalaži



611019	8 - 22 / 10	1105	TF	1
🔑 120/1 (8, 10, 11, 12, 13, 14, 15, 17, 19, 22)				

120/1CB

Garnitura dugih viljuškasto-okastih ključeva u kartonskoj ambalaži



611020	10 - 30 / 12	2611	TF	1
🔑 120/1 (10, 11, 12, 13, 14, 15, 17, 19, 22, 24, 27, 30)				

120/1CB

Garnitura dugih viljuškasto-okastih ključeva u kartonskoj ambalaži



619398	1/4" - 1.1/4" / 16	3720	TF	1
🔑 120/1 (1/4", 5/16", 3/8", 7/16", 1/2", 9/16", 5/8", 11/16", 3/4", 13/16", 7/8", 15/16", 1", 1.1/16", 1.1/8", 1.1/4")				

120/1CS

Garnitura dugih viljuškasto-okastih ključeva u kartonskoj ambalaži



603709	8 - 19 / 8	770	TG	1
🔑 120/1 (8, 9, 10, 12, 13, 14, 17, 19)				

120/1CT

Ključevi viljuškasto-okasti, dugi - u torbici



615475	8 - 22 / 8	1050	TT	1
🔑 120/1 (8, 10, 11, 13, 15, 17, 19, 22), CT129 (470 x 330)				

120/1MS

Ključevi viljuškasto-okasti, dugi - na metalnom stalku



605537	6 - 22 / 17	2765	TF	1
🔑 120/1 (6, 7, 8, 9, 10, 11, 12, 13, 14, 15, 16, 17, 18, 19, 20, 21, 22), 977/2 (6 - 22/17)				

125/1

Ključ viljuškasto-okasti kratki

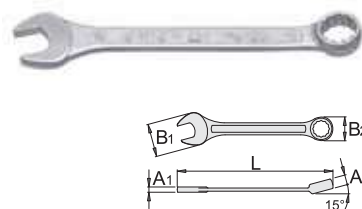

- Materijal: Premium krom-vanadij
- kovan, u cijelosti ojačan i zakaljen
- kromirani (ISO 1456:2009)
- polirane glave
- obuhvatni dio sa LIFE profilom
- izrađeni prema standardu ISO 7738 (samo metričke dimenzije)
- izrađen prema standardu ISO 3318 in 3113A (samo metričke dimenzije)



618651	5	84	5.8	12	3	3	9	4A	10
618652	5.5	84	5.8	12	3	3	9	4A	10
600414	6	100	10.4	14.5	5	3.5	11	4A	10
600415	7	109	11.5	16.5	5.8	3.9	15	4A	10
600416	8	119	13.2	18.5	6.9	3.9	20	4A	10

600417	9	123	14.3	21	7.3	4	25	4A	10
600418	10	128	15.9	23	7.5	4.2	29	4A	10
600419	11	135	17.8	24.5	8	4.5	35	4A	10
600420	12	139	19.4	26.5	8.5	4.7	45	4A	10
600421	13	150	20.4	29.5	8.5	5.2	54	4A	10
600422	14	160	22	31.5	9	5.2	63	4A	10
600423	15	170	23.2	33.5	9.5	5.7	78	4A	10
600424	16	180	24.8	36	10.5	6.2	95	4A	10
600425	17	190	26.1	38	10.5	6.7	121	4A	10
600426	18	200	27.7	40	11	7.2	135	4A	10
600427	19	210	29.3	42	12	7.2	157	4A	10
600428	20	220	31	44	12.5	7.7	186	4A	10
600429	21	230	32.6	45.5	13	8.2	198	4A	10
600430	22	247	34.1	46.5	13	8.2	230	4A	10
602089	23	250	35.7	50.5	13	8.2	254	4A	5
602090	24	266	37.3	52.5	14	8.5	300	4A	5
602091	25	270	39	54.5	14.5	8.5	330	4A	5
602092	26	275	40.1	56	15	8.5	342	4A	5
602093	27	292	41.6	57.5	15	9	365	4A	5
602094	28	296	43.2	59.5	15.5	9	432	4A	5
602095	29	300	44.9	61.5	16	9.5	455	4A	5
602096	30	323	46.5	63.5	16	10	522	4A	5
602097	32	343	49	68	16.5	10.5	602	4A	5
603332	36	400	54.5	79.5	20	13.5	1115	TC	1
618566	41	420	62	86.8	21	14.6	1575	TC	1
618570	46	440	69	94	23	16	1985	TC	1

125/1CB

Garnitura kratkih viljuškasto-okastih ključeva u kartonskoj ambalaži



600431	6 - 22 / 17	1590	TF	1
🔑 125/1 (6, 7, 8, 9, 10, 11, 12, 13, 14, 15, 16, 17, 18, 19, 20, 21, 22)				

125/1CB

Garnitura kratkih viljuškasto-okastih ključeva u kartonskoj ambalaži



602098	6 - 32 / 26	5240	TF	1
🔑 125/1 (6, 7, 8, 9, 10, 11, 12, 13, 14, 15, 16, 17, 18, 19, 20, 21, 22, 23, 24, 25, 26, 27, 28, 29, 30, 32)				



129/1

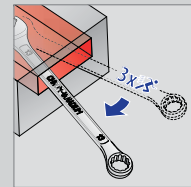

Omoгућава tri puta brži rad u usporedbi sa standardnim viljuškasto-okastim ključevima

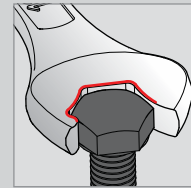

100% pozicioniranje ključa

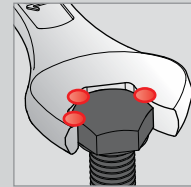

3 brida za jaču snagu

125/1CB

Garnitura kratkih viljuškasto-okastih ključeva u kartonskoj ambalaži



611021	8-22/10	893	TF	1
🔑 125/1 (8, 10, 11, 12, 13, 14, 15, 17, 19, 22)				

125/1CT

Garnitura kratkih viljuškasto-okastih ključeva u torbici



615478	8-22/8	851	TT	1
🔑 125/1 (8, 10, 11, 13, 15, 17, 19, 22), CT110				

129/1

Ključ viljuškasto-okasti IBEX

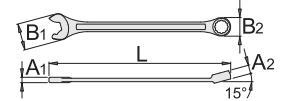

- materijal: Premium krom-vanadij
- Kovan, u cijelosti ojačan i zakaljen
- kromirani (ISO 1456:2009)
- polirane glave
- obuhvatni dio sa LIFE profilom

Prednosti:

- Sila djeluje na rubove matice kako bi se izbjegla oštećenja.
- 3 brida za jaču snagu
- 100% pozicioniranje ključa
- Okretanje u suprotnom smjeru bez premještanja ključa

125/1CB

Garnitura kratkih viljuškasto-okastih ključeva u kartonskoj ambalaži



611022	10-30/12	2100	TF	1
🔑 125/1 (10, 11, 12, 13, 14, 15, 17, 19, 22, 24, 27, 30)				

125/1CT

Garnitura kratkih viljuškasto-okastih ključeva u torbici



625675	6-32/26	5580	TT	1
🔑 125/1 (6, 7, 8, 9, 10, 11, 12, 13, 14, 15, 16, 17, 18, 19, 20, 21, 22, 23, 24, 25, 26, 27, 28, 29, 30, 32)				

125/1CS

Garnitura kratkih viljuškasto-okastih ključeva u kartonskoj ambalaži



603711	8-19/8	650	TG	1
🔑 125/1 (8, 9, 10, 12, 13, 14, 17, 19)				

125/1MS

Garnitura kratkih viljuškasto-okastih ključeva na metalnom stalku



605539	6-22/17	2200	TF	1
🔑 125/1 (6, 7, 8, 9, 10, 11, 12, 13, 14, 15, 16, 17, 18, 19, 20, 21, 22), 977/3 (6-22/17)				

		L	B2	B1	A2	A1			
611762	8	140	13.2	18.5	6.9	3.9	22	4A	10
611763	10	160	15.9	23	7.5	4.2	37	4A	10
611764	11	174	17.8	24.5	8	4.5	43	4A	10
611765	12	183	19.4	26.5	8.5	4.7	54	4A	10
611766	13	196	20.4	29.5	8.5	5.2	63	4A	10
611767	14	206	22	31.5	9	5.2	75	4A	10
611768	15	217	23.2	33.5	9.5	5.7	93	4A	10
611769	16	227	24.8	36	10.5	6.2	114	4A	10
611770	17	238	26.1	38	10.5	6.7	131	4A	10
611930	18	250	28	40	11	7.2	155	4A	10
611771	19	261	29.3	42	12	7.2	173	4A	10
611772	22	296	34.1	46.5	13	8.2	258	4A	10
611773	24	321	37.3	52.5	14	8.5	321	4A	5

129/1CB

Ključevi viljuškasto-okasti IBEX u kartonskoj ambalaži



Barcode	Hand	Weight	Material	Quantity
611776	8 - 24 / 12	1480	1F	1
129/1 (8, 10, 11, 12, 13, 14, 15, 16, 17, 19, 22, 24)				

129/1CS

Ključevi viljuškasto-okasti IBEX u kartonskoj ambalaži



Barcode	Hand	Weight	Material	Quantity
611775	8 - 19 / 8	793	1G	1
129/1 (8, 10, 12, 13, 14, 15, 17, 19)				

129/1CT

Ključevi viljuškasto-okasti IBEX u torbici



Barcode	Hand	Weight	Material	Quantity
615474	8 - 22 / 8	989	1T	1
129/1 (8, 10, 11, 13, 15, 17, 19, 22), CT129 (470 x 330)				

CT129

Torbica prazna



- Dimenzije 470 x 330, za art. 129, 120, 130, 180, 202
- "čičak" traka za lako otvaranje i zatvaranje
- nije potreban remen za zatvaranje
- materijal: poliestersko platno

Barcode	A x B	Weight	Material	Quantity
615464	470 x 330	150	1E	1

179/2

Ključ okasti ojačani

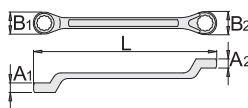

- materijal: Premium krom-vanadij
- Kovan, u cijelosti ojačan i zakaljen
- kromirani (ISO 1456:2009)
- za montiranje građevinske skele



Barcode	Hand	L	B1	B2	A1	A2	Weight	Material	Quantity
605042	21 x 22	316	34	35	17	17	657	4A	5

178/2

Ključ okasti jednostrani, savijeni

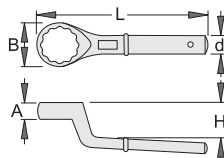

- materijal: Premium krom-vanadij
- kovan, u cijelosti ojačan i zakaljen
- kromirani (ISO 1456:2009)



Barcode	Hand	A	B	d	H	L	Weight	Material	Quantity
620821	24	17	42	18.5	30	180	481	1F	5
620822	27	17	42	18.5	30	180	456	1F	5
620823	30	17	42	18.5	30	180	454	1F	5
620824	32	18	50	20.5	35	235	733	1F	5
620825	36	18	50	20.5	35	235	686	1F	5
620826	41	18	55	20.5	35	235	712	1F	1
620827	46	22	70	23.5	40	265	1208	1F	1
620828	50	22	70	23.5	40	265	1218	1F	1
620829	55	22	75	23.5	40	265	1156	1F	1
620830	60	30	94	29.5	50	345	2512	1F	1
620831	65	30	94	29.5	50	345	2582	1F	1

Barcode	Hand	A	B	d	H	L	Weight	Material	Quantity
620832	70	35	107	29.5	55	365	2909	1F	1
620833	75	35	107	29.5	55	365	2850	1F	1
620834	80	40	125	29.5	59	385	3900	1F	1
620835	85	40	125	29.5	59	385	3741	1F	1
620836	90	45	140	29.5	63	410	3941	1F	1
620837	95	45	140	29.5	63	410	4141	1F	1

178.1/2

Ručica za 178/2

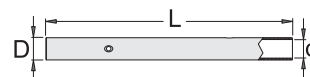

- materijal: Premium krom-molibden
- kromirani (ISO 1456:2009)

Barcode	Hand	D	d	L	Weight	Material	Quantity
620840	24 - 30	25	19	460	744	1F	1
620841	32 - 41	27	21	610	1049	1F	1
620842	46 - 55	30	24	760	1509	1F	1
620843	60 - 95	37	30	860	2476	1F	1

180/1

Ključ okasti

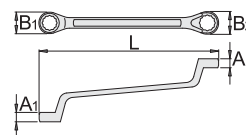

- materijal: Premium krom-vanadij
- kovan, u cijelosti ojačan i zakaljen
- kromirani (ISO 1456:2009)
- polirane glave
- obuhvatni dio sa LIFE profilom
- izrađeni prema standardu ISO 10104 (samo metričke dimenzije)



Barcode	Hand	L	B1	B2	A1	A2	Weight	Material	Quantity
600511	6 x 7	178	10.3	11.8	5.5	6.1	48	4A	10
600512	8 x 9	190	14	15.5	6.7	7.3	60	4A	10
600513	8 x 10	166	12.9	15.5	6	8	50	4A	10
602663	9 x 11	205	15.5	18.5	7.3	8.4	65	4A	10
600514	10 x 11	205	17	18.5	7.9	8.4	81	4A	10
602997	10 x 12	210	17	20	7.9	9	86	4A	10
600516	12 x 13	220	20	21.5	9	9.5	108	4A	10

	L	B1	B2	A1	A2			
600517	12 x 14	205	17.7	20.3	9	10	95	4A 10
600518	13 x 15	235	21.5	24	9.5	10.5	144	4A 10
600519	13 x 17	258	21.5	27	9.5	11.5	172	4A 10
600520	14 x 15	235	23	24	10	10.5	140	4A 10
600521	14 x 17	257	19.8	23.6	10	12	173	4A 10
600522	16 x 17	258	26	27	11	11.4	187	4A 10
603123	16 x 18	259	22.9	25.4	11	12	205	4A 10
600523	17 x 19	270	27	30	11.4	12.4	233	4A 10
600524	18 x 19	270	29	30	11.9	12.4	230	4A 10
600525	19 x 22	295	30	35	12.4	13.7	308	4A 5
600526	20 x 22	295	32	35	12.8	13.7	320	4A 5
600527	21 x 23	305	33	37	13.3	14.1	336	4A 5
600528	22 x 24	315	35	38	13.7	14.6	368	4A 5
600529	24 x 26	325	38	41	14.6	15.4	459	4A 5
600530	24 x 27	325	38	42	14.6	15.8	453	4A 5
600531	25 x 28	335	40	44	15	16.2	522	4A 5
600532	27 x 29	335	42	45	15.8	16.6	589	4A 5
600533	27 x 30	360	38.5	42.7	15	16	647	4A 5
600534	27 x 32	360	42	49	15.8	17.8	672	4A 5
600535	30 x 32	370	46	49	17	17.8	680	4A 5
603845	30 x 34	366	42.7	47.2	15	17	645	TC 5
603124	30 x 36	395	43	48	15	18	845	TC 1
600536	32 x 36	410	48.2	54.2	17.8	19.4	915	TC 1
600537	36 x 41	450	48	56	19	21	945	TC 1
602664	41 x 46	472	56	61	21	23	1430	TC 1

180/1CB

Garnitura okastih ključeva u kartonskoj ambalaži



	L	B1	B2	A			
600541	6 - 22 / 8	1230			TF		1

180/1CB

Garnitura okastih ključeva u kartonskoj ambalaži



	L	B1	B2	A			
603674	6 - 27 / 10	2020			TF		1

**180/1CB**

Garnitura okastih ključeva u kartonskoj ambalaži



	L	B1	B2	A			
600542	6 - 32 / 12	3275			TF		1

180/1CB

Garnitura okastih ključeva u kartonskoj ambalaži



	L	B1	B2	A			
600543	6 - 41 / 13	4465			TF		1

180/1CS

Garnitura okastih ključeva u kartonskoj kutiji



	L	B1	B2	A			
602845	6 - 22 / 8	1320			TG		1

180/1CT

Garnitura okastih ključeva u torbici



	L	B1	B2	A			
615473	6 - 22 / 8	1319			TT		1

180/1PB

Garnitura okastih ključeva u plastičnom etuiu

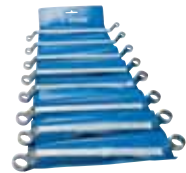

	L	B1	B2	A			
600544	6 - 22 / 8	1240			TE		1

180/1MS

Garnitura okastih ključeva na metalnom stalku



	L	B1	B2	A			
605545	6 - 32 / 12	4171			TF		1

182/2A

Ključ okasti, ravni



- materijal: Premium krom-vanadij
- kovan, u cijelosti ojačan i zakaljen
- kromirani (ISO 1456:2009)
- obuhvatni dio sa LIFE profilom
- izrađeni prema standardu DIN 837 (samo metričke dimenzije)

	L	B1	B2	A			
612004	6 x 7	97	10	11.3	4.6	11	4A 10
612005	8 x 9	112	12.7	14	5.6	19	4A 10
612006	10 x 11	132	15.6	16.5	6.6	29	4A 10
612007	12 x 13	147	18	19	7.6	44	4A 10
613223	13 x 17	167	19	24.2	8.6	73	4A 10
612008	14 x 15	162	20.5	21.5	7.6	59	4A 10
612009	16 x 17	172	23.2	24.2	8.6	90	4A 10
612010	18 x 19	186	25.9	27.4	9.6	112	4A 10

	L	B1	B2	A			
612011	20 x 22	206	28.9	31.8	11	161	4A 5
612013	24 x 26	258	34.8	37.3	11.5	289	4A 5
612015	27 x 29	298	38.3	41.8	13	378	4A 5
612016	30 x 32	318	42.7	45.2	13.5	467	4A 5

182/2ACB

Garnitura ravnih okastih ključeva u kartonskoj ambalaži



	L	B1	B2	A			
612567	6 - 22 / 8	576				TF	1
	182/2A (6 x 7, 8 x 9, 10 x 11, 12 x 13, 14 x 15, 16 x 17, 18 x 19, 20 x 22)						

182/2ACB

Garnitura ravnih okastih ključeva u kartonskoj ambalaži



	L	B1	B2	A			
612568	6 - 32 / 11	2275				TF	1
	182/2A (6 x 7, 8 x 9, 10 x 11, 12 x 13, 14 x 15, 16 x 17, 18 x 19, 20 x 22, 24 x 26, 27 x 29, 30 x 32)						

182/2BTX

Ključ okasti sa TX profilom, savijeni



- materijal: Premium krom-vanadij
- kovan, u cijelosti ojačan i zakaljen
- kromirani (ISO 1456:2009)
- glave savijene pod kutem od 15° omogućavaju pritezanje i odvijanje na teško pristupačnim mjestima



	L	B1	B2	A			
612892	E6 x E8	97	10	11.3	4.6	13	4A 10
612893	E10 x E12	112	12.7	14	5.6	20	4A 10
612894	E14 x E18	137	16.5	21	6.6	38	4A 10
612895	E20 x E24	174	23	27.3	8.6	100	4A 10

183/2

Ključ okasti, otvoreni

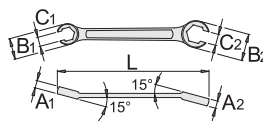

- materijal: Premium krom-vanadij
- kovan, u cijelosti ojačan i zakaljen
- kromirani (ISO 1456:2009)
- šesterokutni obuhvatni dio do dim 12x14, dvanaestokutni od dim. 16x18 do 30x32

Upotreba

- primjena: u industriji i servisnim radionicama koje intenzivno koriste hidraulične i pneumatske instalacije
- Ovaj se ključ koristi na spojevima gdje je upotreba standardnog okastog ključa nemoguća zbog prirode posla (npr. spojevi čeličnih kablova, hidraulične i cijevi za vodovod i ventili...)



	L	A1	A2	B1	B2	C1	C2			
612701	8 x 10	145	7	8.5	18	20	6	7	48	4A 10
612702	10 x 11	152	8.5	9	20	22	7	8.5	64	4A 10
612703	11 x 13	165	9	11	22	26	8.5	10	88	4A 10
612704	12 x 14	178	10	12	24	28	9	11	125	4A 10
615147	16 x 18	196	12	12.5	30.5	33.5	13	14	203	4A 10
612705	17 x 19	210	13	14	32	35	14	15	204	4A 10
612706	19 x 22	233	14	16	35	41	15	17	242	4A 10
612707	22 x 24	265	16	17	41	45	17	18	297	4A 5
612708	24 x 27	265	17	17	45	48	18	20	367	4A 5
612709	30 x 32	285	21	23	50	52	22	24	552	4A 5

183/2CB

Ključevi okasti otvoreni, u kartonskoj ambalaži



	L	B2	B1	A2	A1		
612985	8 - 22 / 6	824				TF	1
	183/2 (8 x 10, 10 x 11, 11 x 13, 12 x 14, 17 x 19, 19 x 22)						



183/2CB

Ključevi okasti otvoreni u kartonskoj ambalaži



	L	B2	B1	A2	A1		
612986	8 - 32 / 9	2085				TF	1
	183/2 (8 x 10, 10 x 11, 11 x 13, 12 x 14, 17 x 19, 19 x 22, 22 x 24, 24 x 27, 30 x 32)						

183/2CT

Ključevi okasti otvoreni, u torbici



	L	B2	B1	A2	A1		
615467	8 - 24 / 6	1065				TF	1
	183/2 (8 x 10, 11 x 13, 12 x 14, 16 x 18, 17 x 19, 22 x 24), CT252						

160/2

Ključ viljuškasto-okasti, s računom

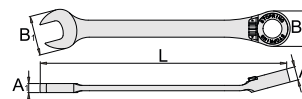

- materijal: Premium krom-vanadij
- kovan, u cijelosti ojačan i zakaljen

Prednosti:

- račna: dvosmjerna, smjer zatezanja/otpuštanja podešava se pomoću gumba
- 72 zuba, pomak 5°
- "zaustavni" prsten na okastom dijelu ključa sprječava proklizavanje ključa s matice i pozicionira ga nazad na maticu
- omogućava brzo i lako pritezanje matice i brzo, sigurno i precizno pozicioniranje ključa na maticu

	L	B2	B1	A2	A1		
622818	8	134	17,1	16,7	8,4	4,7	40 4A 10
622819	9	158	21	21	8,4	5,5	55 4A 10
622820	10	158	21	21	8,4	5,5	60 4A 10
622821	11	164	22,6	23	9,7	6	70 4A 10
622822	12	167	23,8	25	9,7	6,2	80 4A 10
622823	13	177	24,9	27,5	9,7	6,0	96 4A 10
622824	14	189	27	29	10,1	7	125 4A 10
622825	15	198	28,1	31,5	11,7	7,2	150 4A 10
622826	16	204	29,9	33	11,7	7,5	165 4A 10

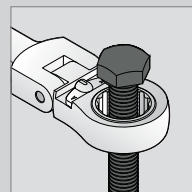

Bez zaustavnog prstena.

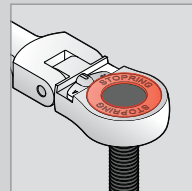

"Zaustavni" prsten na okastom dijelu ključa sprječava proklizavanje ključa s matice i pozicionira ga nazad na maticu.

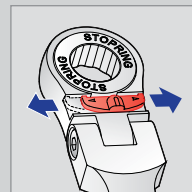

Račna: dvosmjerna, smjer zatezanja/otpuštanja podešava se pomoću gumba.

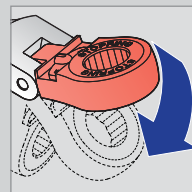

Omogućava rad sa nagibom prstena glave do max. 90°.

Barcode	⊖	L	B2	B1	A2	A1	👤	🔧	📦
622827		17	224	31,9	34,9	11,7	8	183	4A 10
622828		18	245	34,4	38,9	12	8,8	210	4A 10
622829		19	245	34,4	38,9	19	12	230	4A 10
622831		21	280	45,7	42,6	14,2	9,5	358	4A 5
622832		22	280	45,7	42,6	14,2	9,5	378	4A 5
622834		24	310	51,7	46,5	14,7	10	480	4A 5

160/2CB

Ključevi viljuškasto-okasti, s račnom, u kartonskoj ambalaži



Barcode	👤	👤	🔧	📦
623080	8 - 24 / 9	1920	TF	1
160/2 (8, 10, 13, 16, 17, 18, 19, 22, 24)				

160/2CB

Ključevi viljuškasto-okasti, s račnom, u kartonskoj ambalaži



Barcode	👤	👤	🔧	📦
622463	8 - 19 / 7	1800	TF	1
160/2 (8, 10, 12, 13, 14, 17, 19)				

160/2CS

Ključevi viljuškasto-okasti s račnom, u kartonskoj ambalaži



Barcode	👤	👤	🔧	📦
623709	8 - 19 / 6	821	TG	1
160/2 (8, 10, 13, 15, 17, 19)				

160/2CT

Garnitura viljuškasto okastih ključeva s račnom, u torbici



Barcode	👤	👤	🔧	📦
627001	8 - 19 / 6	855	TT	1
160/2 (8, 10, 13, 15, 17, 19), CT252				



161/2

Ključ viljuškasto-okasti, zglobni, s račnom

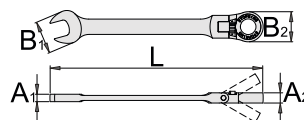

- materijal: Premium krom-vanadij
- kovan, u cijelosti ojačan i zakaljen

Prednosti:

- račna: dvosmjerna, smjer zatezanja/otpuštanja podešava se pomoću gumba
- 72 zuba, pomak 5°
- "zaustavni" prsten na okastom dijelu ključa sprječava proklizavanje ključa s matice i pozicionira ga nazad na maticu
- omogućava brzo i lako pritezanje matice i brzo, sigurno i precizno pozicioniranje ključa na maticu

Barcode	⊖	L	B2	B1	A2	A1	👤	🔧	📦
622839		8	136	17,4	16,9	8,4	4,9	50	4A 10
622841		10	160	20,9	20,8	8,4	3,8	72	4A 10
622842		11	177,5	23,4	25,1	9,7	6,2	95	4A 10
622843		12	177,5	23,4	25,1	9,7	6,2	95	4A 10
622844		13	187,3	24,9	27,2	9,7	6,4	124	4A 10
622845		14	194,7	27,4	29,3	10,1	7	144	4A 10
622846		15	218	30,4	33	11,7	7,4	207	4A 10
622848		17	234,8	31,9	35,2	11,7	8,2	236	4A 10

622850	19	251,3	34,5	39,4	12	9	280	4A	10
--------	----	-------	------	------	----	---	-----	----	----

161/2CB

Ključevi viljuškasto-okasti, zglobovi, s račnom, u kartonskoj ambalaži



623081	8 - 19 / 5	1340	1F	1
161/2 (8, 10, 13, 17, 19)				

161/2CS

Ključevi viljuškasto-okasti, zglobovi, s račnom u kartonskoj ambalaži



623710	8 - 19 / 6	1015	1G	1
161/2 (8, 10, 13, 15, 17, 19)				

161/2CT

Garnitura viljuškasto-okastih ključeva s račnom, u torbici



627002	8 - 19 / 6	965	1T	1
161/2 (8, 10, 11, 13, 17, 19), CT252				

CT252

Torbica prazna



- za art. 160, 161, 170, 171, 183
- Čičak traka za lako otvaranje i zatvaranje
- Nije potreban remen za zatvaranje
- materijal: poliestersko platno

615155	A x B	98	1E	1
--------	-------	----	----	---

165

Ključ okasti, s račnom

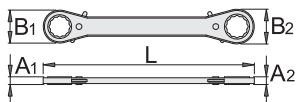

- materijal: račna od krom-vanadija
- tijelo ključa limeno i kromirano
- kućište ključa od specijalne plastike
- u cijelosti ojačan i zakaljen
- minimalni pomak je 20°

	L	B1	B2	A1	A2				
611633	6 x 7	116,2	20,1	20,1	11,2	11,2	60	4A	10
611634	7 x 8	136,3	20,8	23,3	11	11	77	4A	10
611635	8 x 9	136,3	20,8	23,3	11	11	70	4A	10
611636	8 x 10	136,3	20,8	23,3	11	11	68	4A	10
611637	10 x 11	143,8	23,5	26,5	11,1	11,1	77	4A	10
611638	12 x 13	175	30,1	32,1	13	13,4	156	4A	10
611639	12 x 14	175	30,1	32,1	13	13,4	156	4A	10
618769	1/4"x5/16"	116	20,1	20,1	11,2	11,2	60	4A	10
618770	3/8"x7/16"	144	23,5	26,5	11,4	11,1	77	4A	10
618771	1/2"x9/16"	175	30,1	32,1	12,8	12,9	156	4A	10

166

Ključ okasti savijeni, s račnom

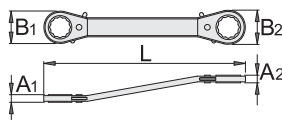

- materijal: račna od Premium krom-vanadija
- tijelo ključa limeno i kromirano
- kućište ključa od posebne plastike
- u cijelosti ojačan i zakaljen
- minimalni pomak je 20°

	L	B1	B2	A1	A2				
611640	6 x 7	111	20	20	11,2	11	60	4A	10
611641	7 x 8	130	20,6	23	11	11,2	77	4A	10
611642	8 x 9	130	20,6	23	11	11,2	69	4A	10
611643	8 x 10	130	20,6	23	11	11,2	67	4A	10
611644	10 x 11	136	23,4	26,4	11	11	77	4A	10
611645	12 x 13	167	30,1	32	13	13,1	153	4A	10
611646	12 x 14	167	30,1	32	13	13,1	153	4A	10

170/2

Ključ okasti, s račnom

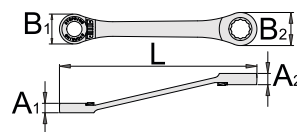

- materijal: Premium krom-vanadij
- kovan, u cijelosti ojačan i zakaljen

Prednosti:

- račna: dvosmjerna, smjer zatezanja/otpuštanja podešava se pomoću gumba
- 72 zuba, pomak 5°
- "zaustavni" prsten na okastom dijelu ključa sprječava proklizavanje ključa s matice i pozicionira ga nazad na maticu
- omogućava brzo i lako pritezanje matice i brzo, sigurno i precizno pozicioniranje ključa na maticu

	L	B2	B1	A2	A1				
622851	6 x 8	114,2	17,4	17,4	8,4	8,4	40	4A	10
622852	8 x 9	130,4	20,9	17,4	8,4	8,4	55	4A	10
622853	8 x 10	130,4	20,9	17,4	8,4	8,4	55	4A	10
622854	10 x 11	144,4	22,9	20,9	9,7	8,4	72	4A	10
622856	12 x 13	166	24,9	23,4	9,7	9,7	97	4A	10
622857	14 x 15	181,4	30,4	27,4	11,7	10,1	142	4A	10
622858	16 x 18	205,9	33,9	30,4	12	11,7	198	4A	10
622859	17 x 19	224,4	34,4	31,9	12	11,7	211	4A	10

170/2CB

Ključevi okasti s račnom, u kartonskoj ambalaži



623082	6 - 19 / 6	800	1F	1
170/2 (6 x 8, 10 x 11, 12 x 13, 14 x 15, 16 x 18, 17 x 19)				

170/2CS

Ključevi okasti s račnom, u kartonskoj ambalaži



623711	6 - 19 / 6	850	1G	1
170/2 (6 x 8, 10 x 11, 12 x 13, 14 x 15, 16 x 18, 17 x 19)				

118/7

Ključ viljuškasti udarni

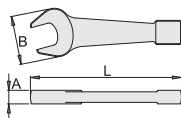

- materijal: Premium poseban alatni čelik
- kovan, u cijelosti ojačan i zakaljen
- završna obrada: antikorozivni premaz uljem
- izrađen prema standardu DIN 133

Barcode	⊖	L	B	A	📦	🔧	📏
620466	24	170	56	15	489	1F	1
620467	27	170	56	15	477	1F	1
620468	30	200	70	18	863	1F	1
620469	32	200	70	18	863	1F	1
620470	36	200	70	18	834	1F	1
620471	41	240	88	20	1490	1F	1
620472	46	240	88	20	1450	1F	1
620473	50	265	102	20	1790	1F	1
620474	55	305	112	24	2700	1F	1
620475	60	305	112	24	2615	1F	1
620476	65	335	123	27	3645	1F	1
620477	70	370	143	30	2200	1F	1
620478	75	370	143	30	4865	1F	1
620479	80	400	175	33	6450	1F	1
620480	85	400	175	33	5775	1F	1
620481	90	450	192	38	7620	1F	1
620482	95	450	192	38	9400	1F	1
620483	100	485	230	45	10800	1F	1
620484	105	485	230	45	10400	1F	1
620485	110	515	235	48	12400	1F	1
620486	115	515	235	52	15800	1F	1
620487	120	535	260	53	20000	1F	1
620488	125	535	260	53	19200	1F	1
620489	130	565	285	53	23200	1F	1
620490	135	565	285	53	23400	1F	1
620491	140	635	307	58	28800	1F	1
620492	145	635	307	58	28800	1F	1
620493	150	635	307	58	28200	1F	1



184/7

Ključ okasti udarni

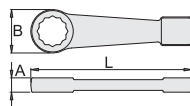

- materijal: Premium poseban alatni čelik
- kovan, u cijelosti ojačan i zakaljen
- završna obrada: antikorozivni premaz uljem
- izrađeni prema standardu DIN 7444 (samo metričke dimenzije)

Barcode	⊖	L	B	A	📦	🔧	📏
620494	24	180	48.6	16	534	1F	1
620495	27	180	48.6	16	514	1F	1
620496	30	180	48.6	16	488	1F	1
620497	32	190	58.4	18	739	1F	1
620498	36	190	58.4	18	694	1F	1
620499	41	235	74	22	1425	1F	1
620500	46	235	74	22	1360	1F	1
620501	50	235	74	22	1335	1F	1
620502	55	275	97.6	27	2800	1F	1
620503	60	275	97.6	27	2710	1F	1
620504	65	275	97.6	27	2580	1F	1
620505	70	335	117	35	4685	1F	1
620506	75	335	117	35	4570	1F	1
620507	80	350	124	35	4305	1F	1
620508	85	358	130	39	4220	1F	1
620509	90	395	144	41	5335	1F	1
620510	95	395	144	39	5090	1F	1
620511	100	420	155	43	6800	1F	1
620512	105	420	155	42	5930	1F	1
620513	110	451	170	46	8200	1F	1
620514	115	450	170	47	8400	1F	1
620515	120	500	190	52	11400	1F	1
620516	125	500	190	53	10800	1F	1
620517	130	525	200	56	13400	1F	1
620518	135	520	200	60	13800	1F	1
620519	140	574	220	61	17000	1F	1
620520	145	574	220	60	16600	1F	1
620521	150	574	220	61	17000	1F	1
620522	1.1/16"	180	49	16	512	1F	1
620523	1.1/8"	180	49	16	511	1F	1
620525	1.1/4"	190	58	18	740	1F	1
620526	1.5/16"	190	58	18	708	1F	1
620527	1.3/8"	190	58	18	700	1F	1
620528	1.7/16"	190	58	18	687	1F	1
620529	1.1/2"	235	74	22	1470	1F	1
620530	1.5/8"	235	74	22	1425	1F	1
620531	1.11/16"	235	74	22	1440	1F	1
620532	1.3/4"	235	74	22	1410	1F	1
620533	1.13/16"	235	74	22	1360	1F	1
620534	1.7/8"	235	74	22	1350	1F	1
620535	2"	235	74	22	1335	1F	1
620536	2.1/16"	275	98	27	1860	1F	1
620537	2.1/8"	275	98	27	2840	1F	1

Barcode	⊖	L	B	A	📦	🔧	📏
620538	2.3/16"	275	98	27	2800	1F	1
620539	2.1/4"	275	98	27	2730	1F	1
620540	2.5/16"	275	98	27	2670	1F	1
620541	2.3/8"	275	98	27	2710	1F	1
620542	2.1/2"	275	98	27	2580	1F	1
620543	2.9/16"	275	98	27	2580	1F	1
620544	2.5/8"	335	117	28.5	4685	1F	1
620545	2.3/4"	335	117	35	4685	1F	1
620546	2.15/16"	335	117	35	4520	1F	1
620547	3"	335	117	35	4570	1F	1
620548	3.1/8"	350	124	35	4305	1F	1
620549	3.3/8"	358	130	39	4220	1F	1
620550	3.1/2"	395	144	41	5335	1F	1
620553	4"	420	155	42	6800	1F	1
620555	4.1/2"	451	170	46	8400	1F	1

255/2

Ključ s nosom

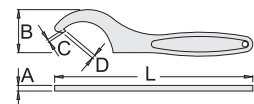

- materijal: Premium krom-vanadij
- u cijelosti ojačan i zakaljen
- kromirani (ISO 1456:2009)
- izrađeni prema standardu DIN 1810

Barcode	⊖	L	C	D	A	B	📦	🔧	📏
613050	12-14	109	1.2	1.5	3	12	27	4A	10
613051	16-20	109	1.5	2	3	12	28	4A	10
613052	25-28	136	2	2.5	4	21	56	4A	10
613053	30-32	136	2	2.5	4	21	55	4A	10
613054	34-36	171	2.5	3	5	28.5	114	4A	10
613055	40-42	171	2.5	3	5	28.5	111	4A	10
613056	45-50	207	3	3.5	6	37	206	4A	10
613057	52-55	207	3	3.5	6	37	209	4A	10
613058	58-62	242	3.5	4	7	46	320	4A	10
613059	68-75	242	3.5	4	7	46	303	4A	10
613060	80-90	281	4	5	8	61	472	4A	10
613061	95-100	281	4	5	8	61	436	4A	10
613062	110-115	334	4	5	10	81	805	1E	10
613063	120-130	334	4	5	10	81	829	1E	5



255/2CT

Ključevi s nosom, u torbici



Barcode	Hand	Weight	Material	Quantity
615156	9	3116	IT	1

255/2 (30 - 32, 40 - 42, 45 - 50, 52 - 55, 58 - 62, 68 - 75, 80 - 90, 95 - 100, 110 - 115)

255/2F

Ključ s nosom, gibljivi

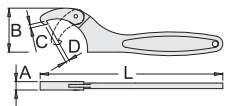

- materijal: Premium krom-vanadij
- u cijelosti ojačan i zakaljen
- kromirani (ISO 1456:2009)

Barcode	Circle	L	C	D	A	B	Weight	Material	Quantity
615027	15 - 35	140	2,5	2,5	7	25	83	4A	10
615028	35 - 50	201	4	4	10	41.5	196	4A	10
615029	50 - 80	262	5	5	12	68	455	4A	10
615030	80 - 120	320	5.5	5.5	14	86	829	4A	10
615031	120 - 180	418	7.5	9	16	134	1768	1E	10



193N

Ključ nasadni s T-ručkom



- materijal: tijelo od Premium krom-vanadij-molibdena, u cijelosti ojačano i zakaljeno
- ručica od polipropilena
- kromirani (ISO 1456:2009)

Barcode	Circle	D	L	B	Weight	Material	Quantity
608283	5.5	8.8	230	88	106	4B	10
608284	6	9	230	88	107	4B	10
608285	7	11	230	88	112	4B	10
608286	8	12	230	88	135	4B	10
608287	9	13	230	88	160	4B	10
608288	10	14	230	88	161	4B	10
608289	11	16	230	88	169	4B	10
608290	12	17.5	230	88	196	4B	6
608291	13	18	230	88	199	4B	6
608292	14	20	230	88	208	4B	6
608293	15	22	230	88	212	4B	6
608295	17	23	230	88	223	4B	6

193NTX

Ključ nasadni s unutrašnjim TX profilom i T-ručkom



- materijal: tijelo od Premium krom-vanadij-molibdena, u cijelosti ojačano i zakaljeno
- ručica od polipropilena
- kromiran (ISO 1456:2009)

Barcode	Circle	D	L	B	Weight	Material	Quantity
621376	E10	12	231	89	157	4B	10

196/2

Ključ nasadni s T-ručkom

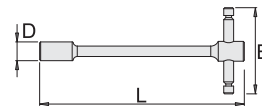
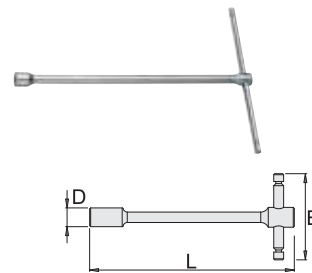

- materijal: Premium krom-vanadij
- u cijelosti ojačan i zakaljen
- kromirani (ISO 1456:2009)

Barcode	Circle	D	B	L	Weight	Material	Quantity
602075	8	12.5	165	235	149	4A	10
602076	10	15	180	260	239	4A	10
605000	11	16	180	260	233	4A	10
605001	12	18	180	260	303	4A	10
602077	13	19.2	180	260	307	4A	10
605002	14	20.2	180	260	311	4A	10
602078	17	24	220	285	499	4A	5

202/1

Ključ nasadni, dvostrani, zglobnj



- materijal: Premium krom-vanadij
- kromirani (ISO 1456:2009)
- kovan, u cijelosti ojačan i zakaljen

Barcode	Circle	L	D1	D2	Weight	Material	Quantity
609132	8 x 9	198	12	13	96	4A	10
609133	8 x 10	200.5	12	14.6	82	4A	10
609134	10 x 11	214	14.6	16	95	4A	10
609135	12 x 13	227	17	18	148	4A	10
609136	13 x 17	242	18	23	213	4A	10
609137	14 x 15	241	19.5	20.5	211	4A	10
609138	16 x 17	255	22	24	295	4A	10
609139	18 x 19	273	24.5	26	391	4A	10
609141	20 x 22	295	27.5	30	518	4A	5



202/1CB

Ključevi nasadni, zglobni u kartonskoj ambalaži



609145	8-22/7	1880	TF	1
202/1 (8 x 9, 10 x 11, 12 x 13, 14 x 15, 16 x 17, 18 x 19, 20 x 22)				

202/1CT

Ključevi nasadni, zglobni u torbici



615472	8-22/8	2122	TT	1
202/1 (8 x 9, 10 x 11, 12 x 13, 13 x 17, 14 x 15, 16 x 17, 18 x 19, 20 x 22), CT129 (470 x 330)				

202/1TX

Ključ nasadni, zglobni, s unutarnjim TX profilom



- materijal: Premium krom-vanadij
- kovan, u cijelosti ojačan i zakaljen
- kromirani (ISO 1456:2009)

		L	D1	D2			
619861	E6 x E8	182	13	13	77	4A	10
619862	E10 x E12	198	15	15	108	4A	10
619863	E14 x E18	226	19	22	197	4A	10
619864	E20 x E24	226	22	26	328	4A	5



202/2AHX

Ključ dvostrani, zglobni, imbus



- materijal: Premium krom-vanadij
- kovan, u cijelosti ojačan i zakaljen
- kromirani (ISO 1456:2009)

		L	D1	D2			
619870	3 x 4	207,5	15	15	110	4A	10
619871	5 x 6	226	18	18	157	4A	10
619872	8 x 10	242	20	20	220	4A	10
619873	12 x 14	248	22	22	260	4A	10
619874	17 x 19	285	24	30	550	4A	10
619875	1/8" x 5/32"	207,5	15	15	109	4A	10
619876	3/16" x 7/32"	223	18	18	157	4A	10
619877	1/4" x 5/16"	225	18	20	174	4A	10
619878	3/8" x 1/2"	240	20	22	242	4A	10
619879	9/16" x 5/8"	255	22	24	331	4A	10

202/2ATX

Ključ dvostrani, zglobni, s TX profilom



- materijal: Premium krom-vanadij
- kovan, u cijelosti ojačan i zakaljen
- kromirani (ISO 1456:2009)

		L	D1	D2			
619865	TX15 x TX20	208	15	15	102	4A	10
619866	TX25 x TX27	208	15	15	108	4A	10
619867	TX30 x TX40	208	15	15	113	4A	10
619868	TX45 x TX50	226	18	18	160	4A	10
619869	TX55 x TX60	240	20	20	231	4A	10

176

Ključ nasadni, dvostrani

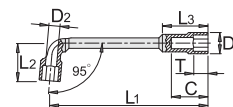

- materijal: Premium krom-vanadij
- kovan, u cijelosti ojačan i zakaljen
- kromirani (ISO 1456:2009)

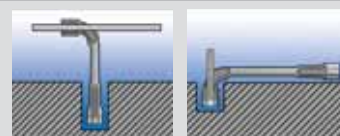

		L1	L2	C	D1	T	L3	D2			
609102	6	104,5	22	22	11	7	29	5	44	4A	10
609103	7	108	25	23	12	8	30,5	5	47	4A	10
609104	8	113	26	27	13	10	30	6,5	76	4A	10
609105	9	118	27	29	14,5	10	33	7	78	4A	10
609106	10	123	31	32	16	11	35	7,5	123	4A	10
609107	11	128,5	32	31	17	12	37	7,5	125	4A	10
609108	12	135	33	34	18	12	40	8,5	161	4A	10
609109	13	143	36,5	40	19	14	47	9	186	4A	10
609110	14	149,5	40	41	21	14	48	10,5	226	4A	10
609111	15	163	41,5	43	22,5	15	50	11	236	4A	10
609112	16	173	46,5	47	24	17	54	13	340	4A	10
609113	17	184,5	46,5	49	25	18	56	13	360	4A	10
609114	18	198	49	51,5	26,5	19,5	58	13	411	4A	10
609115	19	204	52	52,5	28	20,5	62	14	445	4A	10
609116	20	207	53,5	54,5	30	21,5	63	14	495	4A	10
609117	21	216	57	57,5	30,5	23,5	65	15	487	4A	10
609118	22	231	57	58	32	23,5	67	16	590	4A	10
609119	23	238	62	64,5	33,5	24,5	74	18	640	4A	5
609120	24	249	64,5	68,5	34	25,5	77	18	713	4A	5
609121	25	260	67	69,5	36	25,5	79	19,5	703	1C	5
609122	26	270,5	68	70	36	27	81	22	876	1C	5
609123	27	280	68	71	37	25,5	80	20	867	1C	5
609124	28	290,5	70	73,5	38,5	27,5	84	21	1045	1C	5
609125	29	298,5	72	78,5	41	28,5	90	22	1140	1C	5
609126	30	311	75	80,5	42	28,5	93	23	1257	1C	5
609127	32	330,5	79	82,5	45	28,5	95	24	1434	1C	5
609128	35	340	90	97,5	48	35,5	108	25	2200	1C	1
609129	36	376	80	86	50	30	100	25	2235	1C	1

176CB

Garnitura dvostranih, nasadnih ključeva u kartonskoj ambalaži



609130	8-24/16	5230	TF	1
176 (8, 9, 10, 11, 12, 13, 14, 15, 16, 17, 18, 19, 21, 22, 23, 24)				

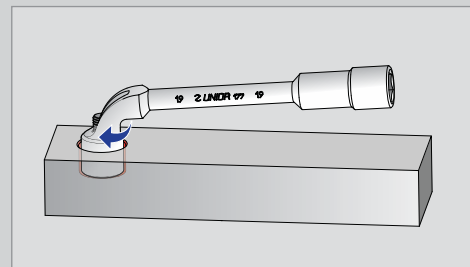

Oblik i otvor ključa omogućavaju otpuštanje matice na dugim navojima.

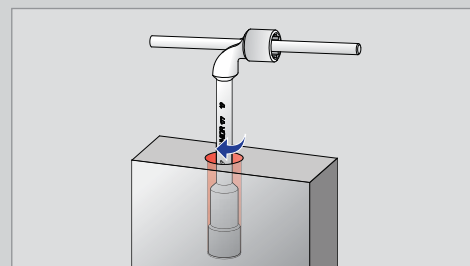

Ključ se zbog svog dubokog profila može koristiti i kao nasadni ključ za duboke matice i navoje

176CB

Garnitura dvostranih nasadnih ključeva u kartonskoj ambalaži



609131	8 - 32 / 22	11800	TF	1
176 (8, 9, 10, 11, 12, 13, 14, 15, 16, 17, 18, 19, 21, 22, 23, 24, 26, 27, 28, 29, 30, 32)				

176CS11

Garnitura dvostranih, nasadnih ključeva u kartonskoj ambalaži



620582	8 - 24 / 11	3650	TG	1
176 (8, 10, 11, 12, 13, 16, 17, 18, 19, 22, 24)				

177

Ključ nasadni, dvostrani, 12-kutni

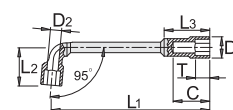

- materijal: Premium krom-vanadij
- kovan, u cijelosti ojačan i zakaljen
- kromirani (ISO 1456:2009)

176CS6

Garnitura dvostranih, nasadnih ključeva u kartonskoj ambalaži



620581	8 - 19 / 6	1365	TG	1
176 (8, 10, 11, 13, 17, 19)				



Barcode	Key Size	L1	L2	C	D1	T	L3	D2	Weight	Material	Quantity
609083	8	113	26	27	13	10	30	6,5	76	4A	10
609084	9	118	27	29	14,5	10	33	7	78	4A	10
609085	10	123	31	32	16	11	35	7,5	123	4A	10
609086	11	128,5	32	31	17	12	37	7,5	125	4A	10
609087	12	135	33	34	18	12	40	8,5	161	4A	10
609088	13	143	36,5	40	19	11	47	9	186	4A	10
609089	14	149,5	40	41	21	14	48	10,5	226	4A	10
609090	15	163	41,5	43	22,5	15	50	11	236	4A	10
609091	16	173	46,5	47	24	17	54	13	340	4A	10
609092	17	184,5	46,5	49	25	18	56	13	360	4A	10
609093	18	198	49	51,5	26,5	19,5	58	13	411	4A	10
609094	19	204	52	52,5	28	20,5	62	14	445	4A	10
609095	20	207	53,5	54,5	30	21,5	63	14	495	4A	10

Barcode	⊖	L1	L2	C	D1	T	L3	D2	👤	🔧	📏
609096	21	216	57	57,7	30,5	23,5	65	15	487	4A	10
609097	22	231	57	58	32	23,5	67	16	590	4A	10
609098	23	238	62	64,5	33,5	24,5	74	18	640	4A	5
609099	24	249	64,5	68,5	34,5	25,5	77	18	713	4A	5

177CB

Ključevi nasadni, dvostrani, dvanaesterokutni u kartonskoj ambalaži



Barcode	👤	🔒	🔧	📏
609100	8 - 24 / 16	5230	1F	1
🔑 177 (8, 9, 10, 11, 12, 13, 14, 15, 16, 17, 18, 19, 21, 22, 23, 24)				

177CS6

Garnitura dvostranih, dvanaesterokutnih nasadnih ključeva u kartonskoj ambalaži



Barcode	👤	🔒	🔧	📏
620583	8 - 19 / 6	1365	1G	1
🔑 177 (8, 10, 11, 13, 17, 19)				

177CS11

Garnitura dvostranih, dvanaesterokutnih nasadnih ključeva u kartonskoj ambalaži



Barcode	👤	🔒	🔧	📏
620584	8 - 24 / 11	3650	1G	1
🔑 177 (8, 10, 11, 12, 13, 16, 17, 18, 19, 22, 24)				

**215/2**

Ključ cijevasti

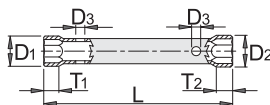

- materijal: Premium krom-molibden
- u cijelosti ojačan i zakaljen
- kromirani (ISO 1456:2009)
- izrađen prema standardu DIN 896 (samo metričke dimenzije)

Barcode	⊖	L	D1	D2	D3	T1	T2	👤	🔧	📏
600696	6 x 7	105	10	11.2	6.3	8	8	28	4A	10
600697	8 x 9	105	12.7	14	6.3	9	9	39	4A	10
600698	8 x 10	120	12.8	15	6.3	8	8	64	4A	10
600699	10 x 11	120	15.5	16.7	6.3	10	10	64	4A	10
600700	12 x 13	140	18.2	19.5	8.5	12	12	104	4A	10
600717	13 x 17	150	20	24.6	10.5	13	13	144	4A	10
600701	14 x 15	140	21.2	22.3	8.5	14	14	134	4A	10
600718	14 x 17	150	21.2	24.6	10.5	13	13	142	4A	10
600702	16 x 17	150	23.5	24.6	10.5	15	15	158	4A	10
600719	17 x 19	160	24.6	27	12.5	16	16	183	4A	10
600703	18 x 19	155	25.8	27	12.5	16	16	184	4A	10
605044	19 x 22	170	27	31.4	12.5	18	18	266	4A	10
607960	19 x 24	160	27	33.7	14.5	20	20	230	4A	10
600705	20 x 22	165	29	31.4	12.5	18	18	269	4A	10
600706	21 x 23	165	30.3	32.5	14.5	20	20	282	4A	5
607962	22 x 24	160	31.4	33.7	14.5	20	20	299	4A	5
600707	24 x 26	185	33.7	36	14.5	22	22	356	4A	5
600723	24 x 27	190	33.7	37.2	14.5	22	22	374	4A	5
600708	25 x 28	200	34.8	38.3	16.5	24	24	432	1E	5
600709	27 x 32	200	38.1	44	16.5	27	27	536	1E	5
602557	30 x 32	200	41.6	44	16.5	27	27	585	1E	5
603128	30 x 36	215	42.6	49.6	18.5	28	28	730	1E	5
603129	36 x 41	215	51.6	57.4	18.5	31	31	1070	1E	5
618575	41 x 46	235	52	57	22	34	34	1555	1E	1
618576	46 x 50	235	59	63	22	36	36	2030	1E	1
618577	50 x 55	235	63	68	21	39	39	2030	1E	1

215.1/2

Trn za art. 215

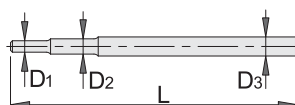

- materijal: Premium krom-molibden
- u cijelosti ojačan i zakaljen
- kromirani (ISO 1456:2009)

Barcode	⊖	L	D1	D2	D3	👤	🔧	📏
600745	6 - 17	230	6	8	10	137	1E	1
600747	18 - 32	330	12	14	16	493	1E	1
624342	36 - 55	500	18	20			1E	1

215/2CB

Ključevi cijevasti u kartonskoj ambalaži



Barcode	👤	🔒	🔧	📏
600710	6 - 32 / 14	3241	1F	1
🔑 215/2 (6 x 7, 8 x 9, 10 x 11, 12 x 13, 14 x 15, 16 x 17, 18 x 19, 20 x 22, 21 x 23, 24 x 26, 25 x 28, 27 x 32), 🔑 215.1/2 (6 - 17, 18 - 32)				

216/1

Ključ cijevasti, kovani

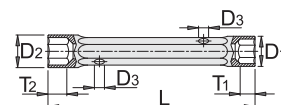

- materijal: Premium krom-vanadij
- u cijelosti ojačan i zakaljen
- kromirani (ISO 1456:2009)
- polirane glave
- izrađen prema standardu DIN 896 (samo metričke dimenzije)

Barcode	⊖	L	D1	D2	T1	T2	D0	👤	🔧	📏
615229	6 x 7	105	10	11	5	6	4	39	4A	10
615230	8 x 9	110	12.5	13.5	6	7	5	54	4A	10
615231	10 x 11	120	15	16	7.5	8	7	66	4A	10
615232	12 x 13	140	17.5	19	8	9.5	8	128	4A	10
615233	14 x 15	145	20	21.5	10	11	8	144	4A	10
615234	16 x 17	155	22.5	24	11	12	10	195	4A	10
615235	18 x 19	165	25.5	26	13	15	12	275	4A	10
615236	20 x 22	175	28	30	15	16	14	289	4A	10



216.1

Trn za art. 216

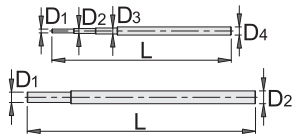

- materijal: Premium krom-vanadij
- u cijelosti ojačan i zakaljen
- kromirani (ISO 1456:2009)

Barcode	↙	D1	D2	D3	D4	L	📦	🔧	📏
615243	6-19	3.5	4.5	5.5	7.5	165	52	1E	10
615244	20-36	9.5	11.8			210	178	1E	10

216/1CB

Ključevi cjevasti kovani u kartonskoj ambalaži



Barcode	👤	📦	🔧	📏
615252	6-22/9	1050	1F	1

216/1 (6 x 7, 8 x 9, 10 x 11, 12 x 13, 14 x 15, 16 x 17, 18 x 19, 20 x 22), 216.1 (6-19)

217/2

Ključ cjevasti, savijeni

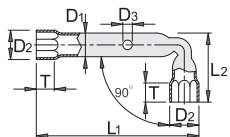

- materijal: Premium krom-molibden
- u cijelosti ojačan i zakaljen
- kromirani (ISO 1456:2009)

Upotreba

- Područje primjene u industriji ili servisima pri radu na teško dostupnim mjestima. Šupljina ključa omogućava zatezanje-otpuštanje matica i sa dužih vijaka

Barcode	⊖	L1	L2	D1	D2	D3	T	📦	🔧	📏
617053	5.5	98	25	7	8.5	4.3	7	18	4A	10
617054	6	103	26	9	10	5.3	8	35	4A	10

Barcode	⊖	L1	L2	D1	D2	D3	T	📦	🔧	📏
617055	7	106	26	9	11,2	5,3	8	36	4A	10
617056	8	112	34	11	12,5	6,3	9	48	4A	10
617057	9	110	34	11	13,5	6,3	9	54	4A	10
617058	10	121	41	13	15,5	6,3	10	82	4A	10
617059	11	120	40	13	16,7	6,3	10	81	4A	10
617060	12	135	46	16	18,2	8,5	12	123	4A	10
617061	13	133	46	16	19,5	8,5	12	126	4A	10
617062	14	138	50	18	21	8,5	14	163	4A	10
617063	15	135	51	18	22,3	8,5	14	163	4A	10
617064	16	143	57	20	23,2	10,5	15	197	4A	10
617065	17	140	56	20	24,6	10,5	15	197	4A	10
617066	18	149	65	22	25,8	12,5	16	234	4A	10
617067	19	150	64	22	27	12,5	16	237	4A	10
617070	22	159	71	25	31,4	12,5	20	353	4A	5
617075	32	190	98	34	44	16,5	27	745	1E	5

217/2CB

Ključevi cjevasti savijeni, u garnituri



Barcode	👤	📦	🔧	📏
617123	6-22/11	1540	1F	1

217/2 (6, 7, 8, 10, 11, 12, 13, 14, 17, 19, 22)

193HX

Ključ imbus s T-ručicom

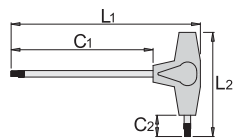

- materijal: tijelo od Premium krom-vanadij-molibdena, u cijelosti ojačano i zakaljeno
- ručica od polipropilena
- tijelo kromirano, vrh brunirano



Barcode	⊖	L1	C1	C2	L2	📦	🔧	📏
623238	2	155	125	15	61	12	4B	1
607161	2.5	155	125	15	61	13	4B	10
607162	3	155	125	15	61	16	4B	10
607163	3.5	155	125	15	61	20	4B	10
607164	4	155	125	15	61	24	4B	10
607165	4.5	188	150	20	88	57	4B	10
607166	5	188	150	20	88	56	4B	10
607167	6	188	150	20	88	74	4B	10
607168	7	223	175	25	113	128	4B	6

Barcode	⊖	L1	C1	C2	L2	📦	🔧	📏
607169	8	223	175	25	113	155	4B	6
607170	10	248	200	25	113	233	4B	6

193HXC

Ključevi imbus s T-ručicom u kartonskoj ambalaži



Barcode	👤	📦	🔧	📏
608879	2.5-10/10	884	1F	1

193HX (2.5, 3, 3.5, 4, 4.5, 5, 6, 7, 8, 10)

193HXS

Ključevi imbus s T-ručicom u kartonskoj ambalaži



Barcode	👤	📦	🔧	📏
607890	2.5-10/7	743	1G	1

193HX (2.5, 3, 4, 5, 6, 8, 10)

193HXS1

Garnitura imbus ključeva s T-ručicom u kutiji



Barcode	👤	📦	🔧	📏
625169	2.5-8/6	470	1G	1

193HX (2.5, 3, 4, 5, 6, 8)



193HXS

Ključ imbus, s kuglom, s T-ručicom

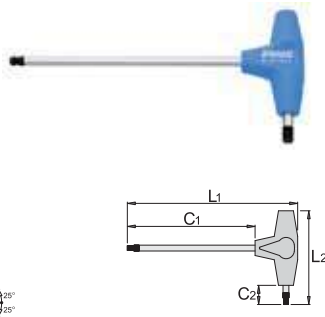

- materijal: tijelo od Premium krom-vanadij-molibdena, u cjelosti ojačano i zakaljeno
- ručica od polipropilena
- tijelo kromirano, vrh bruniran

Barcode	Hex	L1	C1	C2	L2	Weight	Material	Quantity
608276	2.5	155	125	15	61	13	4B	10
608277	3	155	125	15	61	16	4B	10
608278	4	155	125	15	61	25	4B	10
608279	5	188	150	20	88	56	4B	10
608280	6	188	150	20	88	72	4B	10
608281	8	223	175	25	113	153	4B	6
608282	10	248	200	25	113	234	4B	6

193HXSCS

Ključevi imbus, s kuglom, s T-ručicom u kartonskoj ambalaži



Barcode	Hex	Range	Weight	Material	Quantity
609337	2.5 - 10 / 7	739	1G	1	

193HXS (2.5, 3, 4, 5, 6, 8, 10)



193TX

Ključ Torx, s T-ručicom

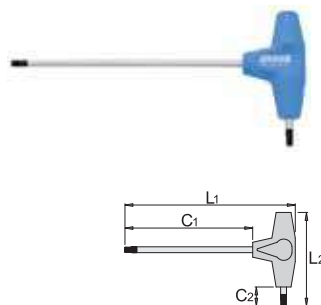

- materijal: tijelo od Premium krom-vanadij-molibdena, u cjelosti ojačano i zakaljeno
- ručica od polipropilena
- kromirano tijelo, brunirani vrh

Barcode	Star	L1	C1	C2	L2	Weight	Material	Quantity
607171	TX 6	155	125	15	61	15	4B	10
607172	TX 7	155	125	15	61	15	4B	10
607173	TX 8	155	125	15	61	15	4B	10
607174	TX 9	155	125	15	61	15	4B	10
607175	TX 10	155	125	15	61	15	4B	10
607176	TX 15	155	125	15	61	19	4B	10
607177	TX 20	155	125	15	61	22	4B	10
607178	TX 25	188	150	20	88	46	4B	10
607179	TX 27	188	150	20	88	58	4B	10
607180	TX 30	188	150	20	88	67	4B	10
607181	TX 40	223	175	25	113	118	4B	6
607182	TX 45	223	175	25	113	142	4B	6

193TXCB

Ključevi Torx s T-ručicom u kartonskoj ambalaži



Barcode	Star	Range	Weight	Material	Quantity
608880	TX 6 - TX 45 / 10	631	1F	1	

193TX (TX 6, TX 8, TX 10, TX 15, TX 20, TX 25, TX 27, TX 30, TX 40, TX 45)

193TXCS

Ključevi Torx s T-ručicom u kartonskoj ambalaži



Barcode	Star	Range	Weight	Material	Quantity
607888	TX 10 - TX 45 / 7	605	1G	1	

193TX (TX 10, TX 15, TX 20, TX 25, TX 30, TX 40, TX 45)

220/3

Ključ imbus

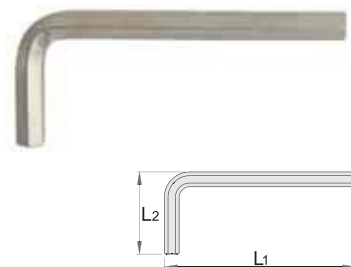

- materijal: Premium krom-vanadij
- u cjelosti ojačan i zakaljeno
- završna obrada: niklovanje
- izrađen prema standardu ISO 2936 (samo metričke dimenzije)

Barcode	Hex	L1	L2	Weight	Material	Quantity
607823	1.5	46.5	15.5	5	4B	10
607824	2	52	18	6	4B	10
607825	2.5	58.5	20.5	7	4B	10
601036	3	66	23	10	4B	10
601037	4	74	29	15	4B	10
601038	5	85	33	23	4B	10
601040	6	96	38	35	4B	10
601041	7	102	41	47	4B	10
601042	8	108	44	65	4B	10
601044	10	122	50	108	4B	10
601045	12	137	57	163	4B	10
601046	14	154	70	258	4B	10
601047	17	177	80	433	1X	5
601048	19	199	89	603	1X	5
616967	3/64"	41	13	5	4B	10
616966	1/20"	41	13	5	4B	10
611905	1/16"	47	16	5	4B	10





220FH

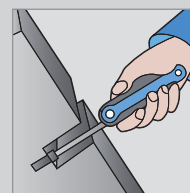
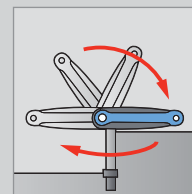
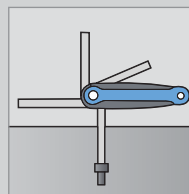

220FH

Ključevi imbus, na plastičnom držaču



617146	2.5 - 10 / 7	300	1X	1
└─ 220/3 (2.5, 3, 4, 5, 6, 8, 10)				

220FH

Ključevi imbus, na plastičnom držaču



617148	3/32" - 5/16" / 6	191	1X	1
└─ 220/3 (3/32", 1/8", 5/32", 3/16", 1/4", 5/16")				

220FH

Ključevi imbus, na plastičnom držaču



617149	3/32" - 3/8" / 7	300	1X	1
└─ 220/3 (3/32", 1/8", 5/32", 3/16", 1/4", 5/16", 3/8")				

220/3PB

Garnitura imbus ključeva u plastičnom etuiu



601057	3 - 10 / 6	237	1X	1
└─ 220/3 (3, 4, 5, 6, 8, 10)				

220/3PB

Garnitura imbus ključeva u plastičnom etuiu



601059	3 - 14 / 8	660	1X	1
└─ 220/3 (3, 4, 5, 6, 8, 10, 12, 14)				

220/3PB

Garnitura imbus ključeva, u plastičnom etuiu



601061	3 - 19 / 10	1715	1X	1
└─ 220/3 (3, 4, 5, 6, 8, 10, 12, 14, 17, 19)				

220/3PB1

Ključevi imbus, u plastičnoj kutiji



610914	2 - 10 / 8	310	1S	1
└─ 220/3 (2, 2.5, 3, 4, 5, 6, 8, 10)				

220/3PB1

Ključevi imbus, u plastičnoj kutiji



<ul style="list-style-type: none"> Garnitura sadrži dimenzije 5/64", 3/32", 1/8", 5/32", 3/16", 1/4", 5/16", 3/8" 				
612161	5/64" - 3/8" / 8	300	1S	1
└─ 220/3 (5/64", 3/32", 1/8", 5/32", 3/16", 1/4", 5/16", 3/8")				

220/3PH

Garnitura imbus ključeva, na plastičnom stalku



607852	1.5 - 10 / 9	250	1X	1
└─ 220/3 (1.5, 2, 2.5, 3, 4, 5, 6, 8, 10)				





220/3PH

Garnitura imbus ključeva, na plastičnom stalku



Barcode	Hand	Weight	Material	Quantity	Unit
617079	1.5 - 12 / 10	416	1X	1	
220/3 (1.5, 2, 2.5, 3, 4, 5, 6, 8, 10, 12)					

220/3MH

Ključevi imbus, na metalnom držaču



Barcode	Hand	Weight	Material	Quantity	Unit
610986	2.5 - 10 / 7	349	1E	1	
220/3 (2.5, 3, 4, 5, 6, 8, 10)					

220/3L

Ključ imbus, dugi

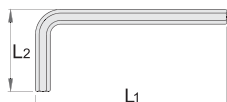

- materijal: Premium krom-vanadij
- u cijelosti ojačan i zakaljen
- završna obrada: niklovanje
- izrađen prema standardu ISO 2936 (samo metričke dimenzije)

Barcode	Hand	L1	L2	Weight	Material	Quantity
608510	1.5	91.5	15.5	6	4B	10
608511	2	102	18	7	4B	10
608512	2.5	114.5	20.5	10	4B	10

Barcode	Hand	L1	L2	Weight	Material	Quantity
608513	3	129	23	14	4B	10
608514	4	144	29	22	4B	10
608515	5	165	33	35	4B	10
608516	6	186	38	55	4B	10
608517	7	197	41	78	4B	10
608518	8	208	44	105	4B	10
608519	10	234	50	105	4B	10
608520	12	262	57	105	4B	10
608521	14	294	70	437	4B	10
608522	17	337	80	753	1X	5
608523	19	379	89	1026	1X	5
616975	1/16"	92	16	6	4B	10
616976	5/64"	102	18	7	4B	10
616977	3/32"	114	20	10	4B	10
616978	1/8"	129	23	14	4B	10
616979	9/64"	140	26	22	4B	10
616980	5/32"	144	29	22	4B	10
616981	3/16"	165	33	35	4B	10
616982	7/32"	176	36	55	4B	10
616983	1/4"	186	38	55	4B	10
616984	5/16"	208	44	105	4B	10
616985	3/8"	234	50	105	4B	10
616986	7/16"	261	53	105	4B	10
616987	1/2"	293	63	105	4B	10
616988	9/16"	294	69	437	4B	10
616989	5/8"	336	76	753	1X	10
616990	3/4"	379	89	1026	1X	5

220/3LPB2

Garnitura dugih imbus kjučeva, u plastičnoj kutiji



Barcode	Hand	Weight	Material	Quantity	Unit
610915	2 - 10 / 8	536	1S	1	
220/3L (2, 2.5, 3, 4, 5, 6, 8, 10)					

220/3LPH

Garnitura dugih imbus ključeva na plastičnom stalku



Barcode	Hand	Weight	Material	Quantity	Unit
608533	1.5 - 10 / 9	416	1X	1	
220/3L (1.5, 2, 2.5, 3, 4, 5, 6, 8, 10)					

220/3LPH

Garnitura dugih imbus ključeva na plastičnom stalku



Barcode	Hand	Weight	Material	Quantity	Unit
617080	1.5 - 12 / 10	700	1X	1	
220/3L (1.5, 2, 2.5, 3, 4, 5, 6, 8, 10, 12)					

220/3LPB

Garnitura dugih imbus ključeva na plastičnom stalku



Barcode	Hand	Weight	Material	Quantity	Unit
617082	1/16" - 3/8" / 9	400	1X	1	
220/3L (1/16", 5/64", 3/32", 1/8", 5/32", 3/16", 1/4", 5/16", 3/8")					



220/3S

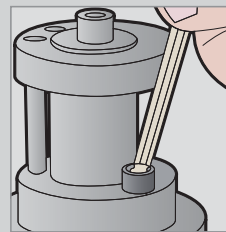

220/3S

Ključ imbus s kuglom

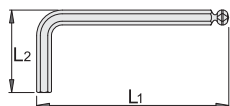

- materijal: Premium krom-vanadij
- u cijelosti ojačan i zakaljen
- završna obrada: niklovanje

Barcode	Hex Size	L1	L2	Weight	Material	Quantity
607826	1.5	46.5	15.5	5	4B	10
607827	2	52	18	6	4B	10
607828	2.5	58.5	20.5	7	4B	10
607829	3	66	23	10	4B	10
607830	4	74	29	15	4B	10
607831	5	85	33	23	4B	10
607832	6	96	38	35	4B	10
607834	8	108	44	65	4B	10
607835	10	122	50	108	4B	10

220/3SFH

Garnitura imbus ključeva s kuglom, na plastičnom držaču



Barcode	Hex Size	Weight	Material	Quantity
617147	2.5 - 10 / 7	298	1X	1

220/3S (2.5, 3, 4, 5, 6, 8, 10)

220/3SPB1

Garnitura imbus ključeva s kuglom, u plastičnoj kutiji



Barcode	Hex Size	Weight	Material	Quantity
610916	2 - 10 / 8	316	1S	1

220/3S (2, 2.5, 3, 4, 5, 6, 8, 10)

220/3SPH

Garnitura imbus ključeva s kuglom, na plastičnom stalku



Barcode	Hex Size	Weight	Material	Quantity
607853	1.5 - 10 / 9	252	1X	1

220/3S (1.5, 2, 2.5, 3, 4, 5, 6, 8, 10)

220/3SL

Ključ imbus s kuglom, dugi

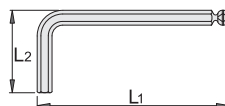

- materijal: Premium krom-vanadij
- u cijelosti ojačan i zakaljen
- završna obrada: niklovanje

Barcode	Hex Size	L1	L2	Weight	Material	Quantity
608524	1.5	91.5	15.5	6	4B	10
608525	2	102	18	7	4B	10
608526	2.5	114.5	20.5	10	4B	10
608527	3	129	23	14	4B	10

Barcode	Hex Size	L1	L2	Weight	Material	Quantity
608528	4	144	29	22	4B	10
608529	5	165	33	35	4B	10
608530	6	186	38	55	4B	10
608531	8	208	44	105	4B	10
608532	10	234	50	105	4B	10

220/3SLPB2

Garnitura dugih imbus ključeva s kuglom, u plastičnoj kutiji



Barcode	Hex Size	Weight	Material	Quantity
610917	2 - 10 / 8	544	1S	1

220/3SL (2, 2.5, 3, 4, 5, 6, 8, 10)

220/3SLPH

Garnitura dugih imbus ključeva s kuglom, na plastičnom stalku



Barcode	Hex Size	Weight	Material	Quantity
608534	1.5 - 10 / 9	425	1X	1

220/3SL (1.5, 2, 2.5, 3, 4, 5, 6, 8, 10)



220/7TX

Ključ imbus s TX profilom i rupicom

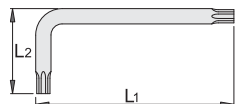

- materijal: Premium krom-vanadij
- u cijelosti ojačan i zakaljen
- Površina: bruniranje

Barcode	Star	L1	L2	Weight	Material	Length
609173	TR 10	65	20	9	4B	10
616296	TR 9	59	19	9	4B	10
609174	TR 15	75.5	20.5	12	4B	10
609175	TR 20	87	22	15	4B	10
609176	TR 25	97.5	22.5	18	4B	10
609177	TR 27	105.5	25.5	25	4B	10
609178	TR 30	111	30	32	4B	10
609179	TR 40	119	33	45	4B	10

220/7TXMH

Ključevi imbus s TX profilom i rupicom, na metalnom držaču



Barcode	Hand	Weight	Material	Length
610987	TR 9 - TR 40 / 8	269	1E	1

220/7TX (TR 9, TR 10, TR 15, TR 20, TR 25, TR 27, TR 30, TR 40)

220/7TXPH

Garnitura imbus ključeva sa TX profilom i rupicom na plastičnom stalku



Barcode	Hand	Weight	Material	Length
613089	TR 9 - TR 40 / 8	130	1X	1

220/7TX (TR 9, TR 10, TR 15, TR 20, TR 25, TR 27, TR 30, TR 40)

220/7TXN

Ključ imbus s TX profilom

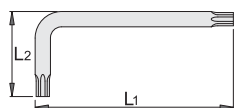

- materijal: Premium krom-vanadij
- u cijelosti ojačan i zakaljen
- Površina: bruniranje

Barcode	Star	L1	L2	Weight	Material	Length
616991	TX 6	46,5	19,5	7	4B	10
616992	TX 7	52,5	19,5	7	4B	10
616993	TX 8	53	20	8	4B	10
616994	TX 9	53	20	8	4B	10
616995	TX 10	56	21	8	4B	10
616996	TX 15	59,5	22,5	10	4B	10
616997	TX 20	63	24	13	4B	10
616998	TX 25	66,5	25,5	15	4B	10
616999	TX 27	71,5	27,5	21	4B	10
617000	TX 30	78	31	25	4B	10
617001	TX 40	85	34	35	4B	10
617002	TX 45	93	38	50	4B	10
617003	TX 50	106	42	67	4B	10
617004	TX 55	122	48	126	4B	10

220/7TXNFH

Ključevi imbus s TX profilom na držaču



Barcode	Hand	Weight	Material	Length
617150	TX 9 - TX 40 / 8	300	1X	1

220/7TXN (TX 9, TX 10, TX 15, TX 20, TX 25, TX 27, TX 30, TX 40)

220/7TXNPH

Garnitura imbus ključeva s TX profilom, na plastičnom stalku



Barcode	Hand	Weight	Material	Length
617077	TX 9 - TX 40 / 8	130	1X	1

220/7TXN (TX 9, TX 10, TX 15, TX 20, TX 25, TX 27, TX 30, TX 40)

210/2

Ključ jednostrani, savijeni

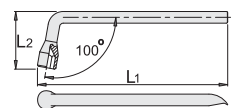

- materijal: Premium krom-vanadij
- kovan, u cijelosti ojačan i zakaljen
- kromirani (ISO 1456:2009)

Barcode	Star	L1	L2	Weight	Material	Length
600782	17	255	27	476	4A	5
600783	19	285	29,5	541	4A	5

212/2

Ključ za kotače

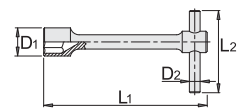

- materijal: Premium krom-vanadij
- kovan, u cijelosti ojačan i zakaljen
- kromirani (ISO 1456:2009)
- izrađen prema standardu ISO DIN 3112

Barcode	Star	L1	D1	L2	D2	Weight	Material	Length
600785	17	260	26	300	12	720	1C	1
600786	19	280	28	300	12	800	1C	1
600788	24	315	33	400	14	1280	1C	1
600789	27	355	38	400	20	2220	1C	1
600790	30	425	42	400	20	2450	1C	1
600791	32	430	47,5	400	20	2815	1C	1





213/6

Ključ križni, za kotače

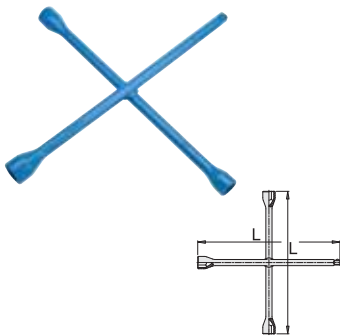

- materijal: Premium krom-vanadij
- kovan, u cijelosti ojačan i zakaljen
- lakirani
- izrađen prema standardu ISO 6788 (samo metričke dimenzije)

Barcode	⊕	⊖	⊗	⊙	L	⊓	⊔	⊕
600811	17	19	22	1/2"	370	1430	1E	1
600809	17	19	21	23	370	1511	1E	1
600812	17	19	22	24	370	1500	1E	1
600813	24	27	30	3/4"	700	4400	1E	1
600814	24	27	30	32	700	4600	1E	1

185/2

Ključ za svječiće, cijevasti

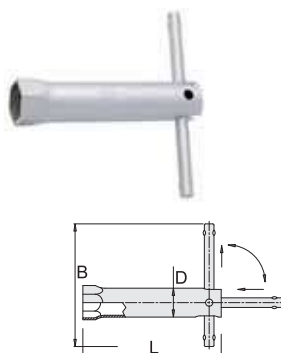

- materijal: Premium poseban alatni čelik
- kromirani (ISO 1456:2009)

Barcode	⊕	D	L	B	⊓	⊔	⊕
600771	16	19	145	120	182	1E	10
607956	19	22	115	120	199	1E	10
600772	21	24	115	120	177	1E	10
600773	21	24	180	120	248	1E	10

175/2

Ključ za ispuštanje ulja

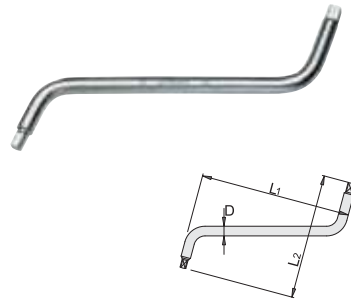

- materijal: Premium krom-vanadij
- u cijelosti ojačan i zakaljen
- kromirani (ISO 1456:2009)

Barcode	■	L1	L2	D	⊓	⊔	⊕
605112	8 x 10	202	169	13	305	4A	10

205/2

Ključ za filter, s trakom

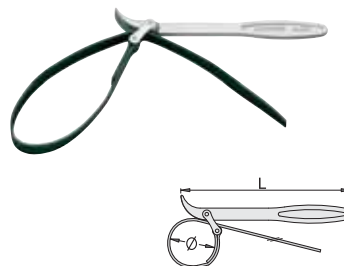

- materijal: Premium krom-vanadij
- gumirana traka
- kovan, u cijelosti ojačan i zakaljen
- kromirani (ISO 1456:2009)

Barcode	⊕	⊖	L	⊓	⊔	⊕
601024	60 - 140	225	225	1E	10	

205.1

Traka za art. 205/2



- gumirana traka

Barcode	⊓	⊔	⊕
602841	62	1E	10



206/2

Ključ za filter, s lancem

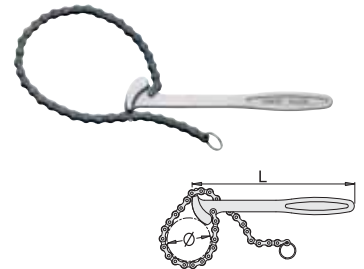

- materijal: Premium krom-vanadij
- kovan, u cijelosti ojačan i zakaljen
- kromirani (ISO 1456:2009)

Barcode	⊕	⊖	L	⊓	⊔	⊕
601025	60 - 140	224,5	330	1E	10	

206.1

Lanac za art. 206/2



Barcode	L	⊓	⊔	⊕
620938	500	150	1E	5

200/2

Ključ za starter

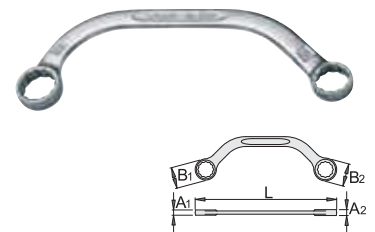

- materijal: Premium krom-vanadij
- kovan, u cijelosti ojačan i zakaljen
- kromirani (ISO 1456:2009)

Barcode	⊕	L	B1	B2	A1	A2	⊓	⊔	⊕
600671	11 x 13	150	16,5	19	7	8,5	54	4A	10
600672	13 x 17	185	19,2	24,2	8,7	10,3	99	4A	10
600673	14 x 17	185	20,5	24,2	8,7	10,3	104	4A	10
600674	15 x 16	185	21,6	23,6	8,7	10,3	104	4A	10
600675	15 x 17	185	21,6	24,2	8,7	10,3	101	4A	10
600676	19 x 22	230	27,2	31,8	10	11,5	178	4A	10

200/2CB

Ključevi za starter u kartonskoj ambalaži



Barcode	⊕	⊖	⊓	⊔	⊕
600677	11 - 22 / 5	605	1E	10	1

200/2 (11 x 13, 13 x 17, 14 x 17, 15 x 16, 19 x 22)