













GREASE NIPPLES

	234 Hydraulic grease nipples H1, straight, 180°
	239 Hydraulic grease nipples H2, 45°
	242 Hydraulic grease nipples H3, 90°
	245 Ball type grease nipples K1
	246 Funnel type grease nipples D1
	248 Funnel type grease nipples D2, angled 45°
	249 Funnel type grease nipples D3, angled 90°
	250 Button head grease nipples M
	252 Button head grease nipples T1/B
	254 Grease nipple assortments Grease nipple tools
	255 Grease nipples, 25 pcs. in polybag
	257 Grease nipples in polybag with headcard

K

GREASE NIPPLES

Hydraulic grease nipples H1, straight, 180°, acc to DIN 71 412, hardened, galvanized, hexagon version



15 025

TECHNICAL DATA

- Norm: DIN 71 412
- Material: steel
- Surface: blue galvanized, hardened
- Surface hardness: 550 HV 1

SPECIFICATION

- Hexagon (SK)

PACKAGING

- Packing unit: 100 (55 602: 50)

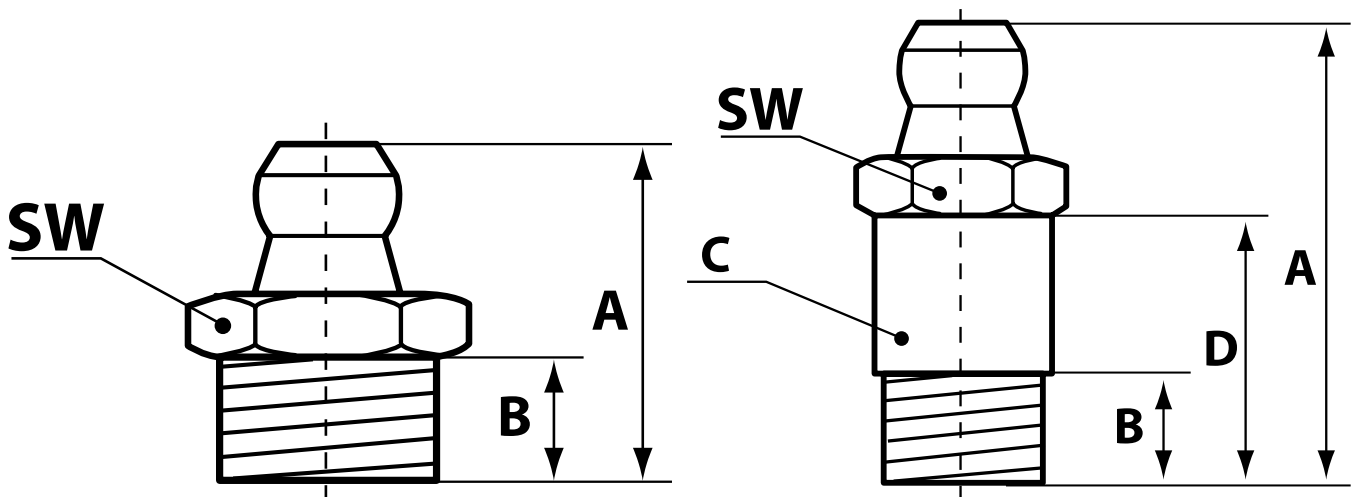

Abbreviations

BSF	British standard fine/Whitworth thread, quality: fine
DIN	German Institute for Standardisation (DIN standards)
G	Whitworth Pipe Thread, cylindrical, ISO 228 (DIN 259)
H1	Hydraulic grease nipple, 180°, straight
M	Metric thread, cylindrical, DIN 13
NPT	National Taper Pipe, non-sealing and pressure-resistant tapered pipe thread
PTF	Pipe Taper Fuel and Oil, sealing and pressure-resistant tapered pipe thread
R	Whitworth thread, tapered, similar to DIN 3858, self-sealing connection
SK	Hexagon
SW	Wrench size
UNF	Unified Fine Thread
VZ	Galvanized
WHIT	Whitworth thread

PRODUCTS

Item-No.	Description 1	Description 2	A	B	C	D
15 006 400	Hydraulic grease nipple H1-straight	M 5 x 0,8-VZ-SK-SW 7	15	5,5		
15 006	Hydraulic grease nipple H1-straight	M 6 x 0,75-VZ-SK-SW 7	15	5,5		
15 007	Hydraulic grease nipple H1-straight	M 6 x 1-VZ-SK-SW 7	15	5,5		
15 007 050	Hydraulic grease nipple H1-straight	M 6 x 1-VZ-SK-SW 7-short	11	3,3		
15 062	Hydraulic grease nipple H1-straight	1/4" UNF-VZ-SK-SW 7	15	5,5		
15 000	Hydraulic grease nipple H1-straight	1/4" BSF-VZ-SK-SW 7	15	5,5		
15 025	Hydraulic grease nipple H1-straight	1/4" WHIT-VZ-SK-SW 7	15	5,5		
15 008	Hydraulic grease nipple H1-straight	M 7 x 1-VZ-SK-SW 9	15	5,5		
15 009	Hydraulic grease nipple H1-straight	M 8 x 1-VZ-SK-SW 9	15	5,5		
15 010	Hydraulic grease nipple H1-straight	M 8 x 1,25-VZ-SK-SW 9	15	5,5		
15 069	Hydraulic grease nipple H1-straight	5/16" BSF-VZ-SK-SW 9	15	5,5		
15 013	Hydraulic grease nipple H1-straight	M 10 x 1-VZ-SK-SW 11	15	5,5		
15 014	Hydraulic grease nipple H1-straight	M 10 x 1,25-VZ-SK-SW 11	15	5,5		
15 015	Hydraulic grease nipple H1-straight	M 10 x 1,5-VZ-SK-SW 11	15	5,5		
15 037	Hydraulic grease nipple H1-straight	G 1/8"-VZ-SK-SW 11	15	5,5		
15 026	Hydraulic grease nipple H1-straight	1/8" NPT-VZ-SK-SW 11	15	5,5		
15 067	Hydraulic grease nipple H1-straight	3/8" WHIT-VZ-SK-SW 11	15	5,5		
15 076	Hydraulic grease nipple H1-straight	3/8" UNF-24F-VZ-SK-SW 11	15	5,5		
15 016	Hydraulic grease nipple H1-straight	M 12 x 1-VZ-SK-SW 14	17	6,5		
15 017	Hydraulic grease nipple H1-straight	M 12 x 1,5-VZ-SK-SW 14	17,5	6,5		
15 018	Hydraulic grease nipple H1-straight	M 12 x 1,75-VZ-SK-SW 14	17,5	6,5		
15 027	Hydraulic grease nipple H1-straight	1/4"-NPT-VZ-SK-SW 14	19	8		
15 021	Hydraulic grease nipple H1-straight	M 14 x 1,5-VZ-SK-SW 14	17,5	6,5		
15 038	Hydraulic grease nipple H1-straight	G 1/4"-VZ-SK-SW 14	17,5	6,5		
15 023	Hydraulic grease nipple H1-straight	M 16 x 1,5-VZ-SK-SW 17	18	7		
15 039	Hydraulic grease nipple H1-straight	G 3/8"-VZ-SK-SW 17	18	7		
15 040	Hydraulic grease nipple H1-straight	R 1/2-VZ-SK-SW 22	28	8		
15 007 001	Hydraulic grease nipple H1-straight	M 6 x 1-VZ-SK-SW 7-long-29 mm	29	8	6	20
55 062	Hydraulic grease nipple H1-straight	1/4" WHIT-VZ-SK-SW 7-long-26 mm	26	6	6,5	16
15 021 003	Hydraulic grease nipple H1-straight	M 14 x 1,5-VZ-SK-SW 14	17,5	6,5		
15 026 007	Hydraulic grease nipple H1-straight	1/8" PTF-VZ-SK-SW 11	15	5,5		

GREASE NIPPLES

Hydraulic grease nipples H1, straight, 180°, acc to DIN 71 412, stainless steel, rustproof, hexagon version



15 906

TECHNICAL DATA

- Norm: DIN 71 412
- Material: stainless steel

SPECIFICATION

- Hexagon (SK)

PACKAGING

- Packing unit: 10

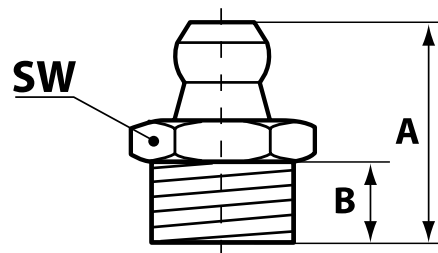

PRODUCTS

Item-No.	Description 1	Description 2	A	B
15 906	Hydraulic grease nipple H1-straight	M 5 x 0,8-VA-SK-SW 7	15	5,5
15 907	Hydraulic grease nipple H1-straight	M 6 x 1-VA-SK-SW 7 -conical	15	5,5
15 909	Hydraulic grease nipple H1-straight	M 8 x 1-VA-SK-SW 9-conical	15	5,5
15 910	Hydraulic grease nipple H1-straight	M 8 x 1,25-VA-SK-SW 9	15	5,5
15 913	Hydraulic grease nipple H1-straight	M 10 x 1-VA-SK-SW 11	15	5,5
15 915	Hydraulic grease nipple H1-straight	M 10 x 1,5-VA-SK-SW 11	15	5,5
15 937	Hydraulic grease nipple H1-straight	R 1/8"-VA-SK-SW 11	15	5,5
15 926	Hydraulic grease nipple H1-straight	1/8" NPT-VA-SK-SW 11	15	5,5
15 917	Hydraulic grease nipple H1-straight	M 12 x 1,5-VA-SK-SW 14	17,5	6,5
15 918	Hydraulic grease nipple H1-straight	M 12 x 1,75-VA-SK-SW 14	17,5	6,5
15 938	Hydraulic grease nipple H1-straight	R 1/4"-VA-SK-SW 14	17,5	6,5
15 939	Hydraulic grease nipple H1-straight	G 3/8" -VA-SK-SW 17	18	7

Abbreviations

DIN	German Institute for Standardisation (DIN standards)
ESN	Drive fit nipple
G	Whitworth Pipe Thread, cylindrical, ISO 228 (DIN 259)
H1	Hydraulic grease nipple, 180°, straight
M	Metric thread, cylindrical, DIN 13
NPT	National Taper Pipe, non-sealing and pressure-resistant tapered pipe thread
R	Whitworth thread, tapered, similar to DIN 3858, self-sealing connection
SFG	Self-forming thread
SK	Hexagon
SW	Wrench size
VA	Stainless steel
VZ	Galvanized

Hydraulic grease nipples H1, straight, 180°, acc to DIN 71 412, hardened, galvanized, self-tapping thread, hexagon version



15 071

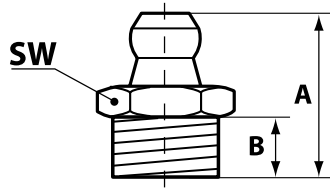

TECHNICAL DATA

- Norm: DIN 71 412
- Dimension A (mm): 15
- Dimension B (mm): 5,5
- Material: steel
- Surface: yellow galvanized
- Surface hardness: 550 HV 1

SPECIFICATION

- Self-forming thread (SFG)
- Hexagon (SK)

PACKAGING

- Packing unit: 100

PRODUCTS

Item-No.	Description 1	Description 2	SW 7	SW 9	SW 11
15 071	Hydraulic grease nipple H1-straight	F 6 x 1-SFG-VZ-SK-SW 7	×		
15 072	Hydraulic grease nipple H1-straight	F 8 x 1-SFG-VZ-SK-SW 9		×	
15 073	Hydraulic grease nipple H1-straight	F 10 x 1-SFG-VZ-SK-SW 11			×

Hydraulic grease nipples H1 A, straight, 180°, acc to DIN 71 412, hardened, galvanized, drive fit version



15 001

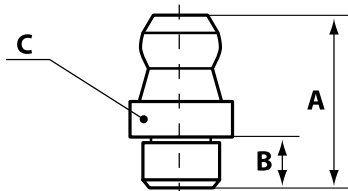

TECHNICAL DATA

- Norm: DIN 71 412
- Material: steel
- Surface: blue galvanized, hardened
- Surface hardness: 550 HV 1

SPECIFICATION

- Drive fit nipple (ESN)

PACKAGING

- Packing unit: 100

PRODUCTS

Item-No.	Description 1	Description 2	A	B	C
15 001	Hydraulic grease nipple H1 A-straight	Ø 4 mm-VZ-round-ESN	15	5,5	8
15 002	Hydraulic grease nipple H1 A-straight	Ø 5 mm-VZ-round-ESN	15	5,5	8
15 003	Hydraulic grease nipple H1 A-straight	Ø 6 mm-VZ-round-ESN	15	5,5	8
15 004	Hydraulic grease nipple H1 A-straight	Ø 8 mm-VZ-round-ESN	15	5,5	10
15 005	Hydraulic grease nipple H1 A-straight	Ø 10 mm-VZ-round-ESN	15	5,5	12

GREASE NIPPLES

Hydraulic grease nipples H1 A, straight, 180°, acc to DIN 71 412, stainless steel, rustproof, drive fit version



15 902

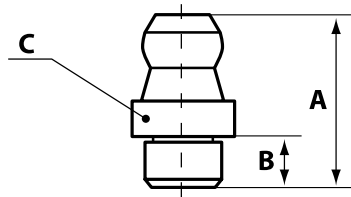

TECHNICAL DATA

- Norm: DIN 71 412
- Material: Stainless steel

SPECIFICATION

- Drive fit nipple (ESN)

PACKAGING

- Packing unit: 10

PRODUCTS

Item-No.	Description 1	Description 2	A	B	C
15 902	Hydraulic grease nipple H1 A-straight	Ø 6 mm-VA-round-ESN	14,4	5,8	8
15 903	Hydraulic grease nipple H1 A-straight	Ø 8 mm-VA-round-ESN	14,9	6,5	8

Abbreviations

BSF	British standard fine/Whitworth thread, quality: fine
DIN	German Institute for Standardisation (DIN standards)
ESN	Drive fit nipple
G	Whitworth Pipe Thread, cylindrical, ISO 228 (DIN 259)
H1 A	Hydraulic grease nipple, 180°, straight, drive fit nipple
H2	Hydraulic grease nipple, 45°
M	Metric thread, cylindrical, DIN 13
NPT	National Taper Pipe, non-sealing and pressure-resistant tapered pipe thread
SK	Hexagon
SW	Wrench size
UNF	Unified Fine Thread
VA	Stainless steel
VZ	Galvanized
WHIT	Whitworth thread

Hydraulic grease nipples H2, 45°, acc to DIN 71 412, hardened, galvanized, hexagon version



15 107 140

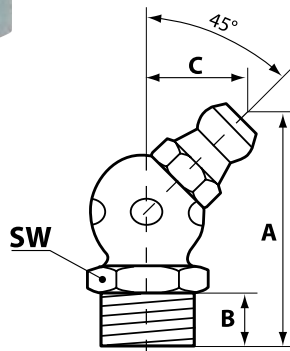

TECHNICAL DATA

- Norm: DIN 71 412
- Material: steel
- Surface: blue galvanized, hardened
- Surface hardness: 550 HV 1

SPECIFICATION

- Hexagon (SK)

PACKAGING

- Packing unit: 100

PRODUCTS

Item-No.	Description 1	Description 2	A	B	C
15 107 140	Hydraulic grease nipple H2-45°	M 6 x 1-VZ-SK-SW 9	23,5	5,5	10,5
15 108	Hydraulic grease nipple H2-45°	M 7 x 1-VZ-SK-SW 9	23,5	5,5	10,5
15 109 140	Hydraulic grease nipple H2-45°	M 8 x 1-VZ-SK-SW 9	23,5	5,5	10,5
15 110 140	Hydraulic grease nipple H2-45°	M 8 x 1,25-VZ-SK-SW 9	23,5	5,5	10,5
15 162 003	Hydraulic grease nipple H2-45°	1/4" WHIT-VZ-SK-SW 9	23,5	5,5	10,5
15 162 140	Hydraulic grease nipple H2-45°	1/4" UNF-VZ-SK-SW 9	23,5	5,5	10,5
15 100 140	Hydraulic grease nipple H2-45°	1/4" BSF-VZ-SK-SW 9	23,5	5,5	10,5
15 163	Hydraulic grease nipple H2-45°	5/16" UNF-VZ-SK-SW 9	23,5	5,5	10,5
15 113 140	Hydraulic grease nipple H2-45°	M 10 x 1-VZ-SK-SW 11	25	5,5	11,5
15 114	Hydraulic grease nipple H2-45°	M 10 x 1,25-VZ-SK-SW 11	25	5,5	11,5
15 115 140	Hydraulic grease nipple H2-45°	M 10 x 1,5-VZ-SK-SW 11	25	5,5	11,5
15 137 140	Hydraulic grease nipple H2-45°	G 1/8"-VZ-SK-SW 11	25	5,5	11,5
15 126	Hydraulic grease nipple H2-45°	1/8" NPT-VZ-SK-SW 11	27	7	11,5
15 164	Hydraulic grease nipple H2-45°	3/8" WHIT-VZ-SK-SW 11	25	5,5	11,5
15 117	Hydraulic grease nipple H2-45°	M 12 x 1,5-VZ-SK-SW 14	22,5	6,5	12
15 118	Hydraulic grease nipple H2-45°	M 12 x 1,75-VZ-SK-SW 14	22,5	6,5	12
15 138	Hydraulic grease nipple H2-45°	G 1/4"-VZ-SK-SW 14	22,5	6,5	12
15 127	Hydraulic grease nipple H2-45°	1/4" NPT-VZ-SK-SW 14	22,5	6,5	12
15 139 004	Hydraulic grease nipple H2-45°	G 3/8"-VZ-SK-SW 17	25,5	7	13,5

GREASE NIPPLES

Hydraulic grease nipples H2, 45°, acc to DIN 71 412, stainless steel, rustproof, hexagon version



15 940

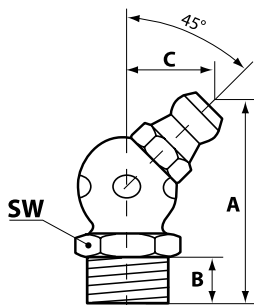

TECHNICAL DATA

- Norm: DIN 71 412
- Material: Stainless steel

SPECIFICATION

- Hexagon (SK)

PACKAGING

- Packing unit: 10

PRODUCTS

Item-No.	Description 1	Description 2	A	B	C
15 940	Hydraulic grease nipple H2-45°	M 6 x 1-VA-SK-SW 9	23,5	5,5	10,5
15 941	Hydraulic grease nipple H2-45°	M 8 x 1-VA-SK-SW 9	23,5	5,5	10,5
15 942	Hydraulic grease nipple H2-45°	M 8 x 1,25-VA-SK-SW 9	23,5	5,5	10,5
15 943	Hydraulic grease nipple H2-45°	M 10 x 1-VA-SK-SW 11	25	5,5	11,5
15 945	Hydraulic grease nipple H2-45°	M 10 x 1,5-VA-SK-SW 11	23,5	5,5	10,5
15 947	Hydraulic grease nipple H2-45°	G 1/8"-VA-SK-SW 11	25	5,5	11,5
15 949	Hydraulic grease nipple H2-45°	G 1/4"-VA-SK-SW 14	22,5	6,5	12

Hydraulic grease nipples H2, 45°, acc to DIN 71 412, hardened, galvanized, square version



15 107

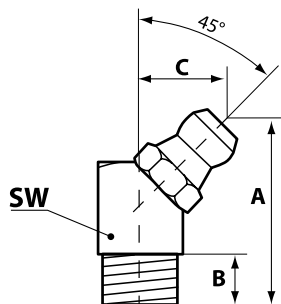

TECHNICAL DATA

- Norm: DIN 71 412
- Material: steel
- Surface: blue galvanized, hardened
- Surface hardness: 550 HV 1

SPECIFICATION

- Square (VK)

PACKAGING

- Packing unit: 100

PRODUCTS

Item-No.	Description 1	Description 2	A	B	C
15 107	Hydraulic grease nipple H2-45°	M 6 x 1-VZ-VK-SW 9	23,5	5,5	10,5
15 109	Hydraulic grease nipple H2-45°	M 8 x 1-VZ-VK-SW 9	20,2	5,5	10,5
15 110	Hydraulic grease nipple H2-45°	M 8 x 1,25-VZ-VK-SW 9	20,2	5,5	10,5
15 162	Hydraulic grease nipple H2-45°	R1/4" UNF-VZ-VK-SW 9	23,5	5,5	10,5
15 100	Hydraulic grease nipple H2-45°	1/4" BSF-VZ-VK-SW 9	23,5	5,5	10,5
15 113	Hydraulic grease nipple H2-45°	M 10 x 1-VZ-VK-SW 11	20,5	5,5	11,5
15 115	Hydraulic grease nipple H2-45°	M 10 x 1,5-VZ-VK-SW 11	20,5	5,5	11,5
15 137	Hydraulic grease nipple H2-45°	G 1/8"-VZ-VK-SW 11	20,5	5,5	11,5

Hydraulic grease nipples H2, 45°, acc to DIN 71 412, hardened, galvanized, self-tapping thread, VK



15 171

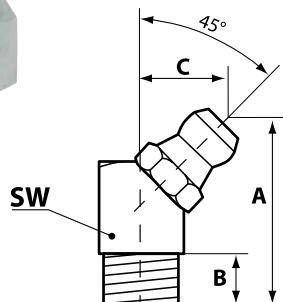

TECHNICAL DATA

- Norm: DIN 71 412
- Material: steel
- Surface: blue galvanized, hardened
- Surface hardness: 550 HV 1

SPECIFICATION

- Self-forming thread (SFG)
- Square (VK)

PACKAGING

- Packing unit: 100

PRODUCTS

Item-No.	Description 1	Description 2	A	B	C
15 171	Hydraulic grease nipple H2-45°	F 6 x 1-SFG-VZ-VK-SW 9	20,5	5,5	10,5
15 171 003	Hydraulic grease nipple H2-45°	F 6 x 1-SFG-VZ-VK-SW 9	20,5	5,5	10,5
15 172	Hydraulic grease nipple H2-45°	F 8 x 1-SFG-VZ-VK-SW 9	20,5	5,5	10,5
15 173	Hydraulic grease nipple H2-45°	F 10 x 1-SFG-VZ-VK-SW 11	20,5	5,5	11

Hydraulic grease nipples H2 A, 45°, acc to DIN 71 412, hardened, galvanized, drive fit version



15 103

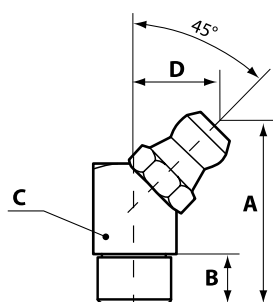

TECHNICAL DATA

- Norm: DIN 71 412
- Material: steel
- Surface: blue galvanized, hardened
- Surface hardness: 550 HV 1

SPECIFICATION

- Drive fit nipple (ESN)

PACKAGING

- Packing unit: 100

PRODUCTS

Item-No.	Description 1	Description 2	A	B	C	D	VK	SK
15 102	Hydraulic grease nipple H2 A-45°	Ø 5 mm-VZ-SK-ESN	20,2	5,5	9	9		×
15 103	Hydraulic grease nipple H2 A-45°	Ø 6 mm-VZ-VK-ESN	20,2	5,5	9	9	×	
15 104	Hydraulic grease nipple H2 A-45°	Ø 8 mm-VZ-VK-ESN	20,2	5,5	9	9	×	
15 105	Hydraulic grease nipple H2 A-45°	Ø 10 mm-VZ-VK-ESN	20,2	5,5	11	9	×	

GREASE NIPPLES

Hydraulic grease nipples H3, 90°, acc to DIN 71 412, hardened, galvanized, hexagon version

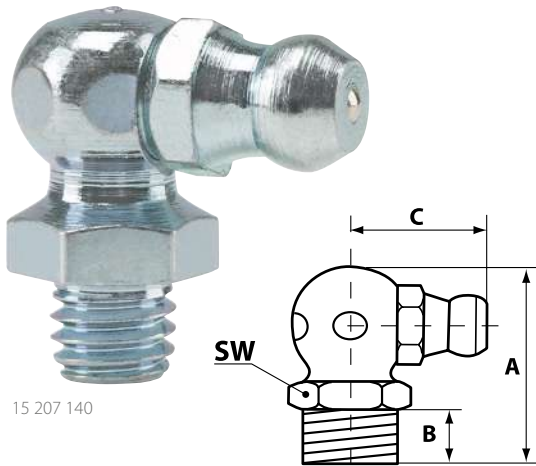

15 207 140

TECHNICAL DATA

- Norm: DIN 71 412
- Material: steel
- Surface: blue galvanized, hardened
- Surface hardness: 550 HV 1

SPECIFICATION

- Hexagon (SK)

PACKAGING

- Packing unit: 100

PRODUCTS

Item-No.	Description 1	Description 2	A	B	C
15 207 140	Hydraulic grease nipple H3-90°	M 6 x 1-VZ-SK-SW 9	18	5,5	13
15 208	Hydraulic grease nipple H3-90°	M 7 x 1-VZ-SK-SW 9	18	5,5	13
15 209 140	Hydraulic grease nipple H3-90°	M 8 x 1-VZ-SK-SW 9	18	5,5	13
15 210 140	Hydraulic grease nipple H3-90°	M 8 x 1,25-VZ-SK-SW 9	18	5,5	13
15 262 140	Hydraulic grease nipple H3-90°	1/4" UNF-VZ-SK-SW 9	18	5,5	13
15 200 140	Hydraulic grease nipple H3-90°	1/4" BSF-VZ-SK-SW 9	18	5,5	13
15 213 140	Hydraulic grease nipple H3-90°	M 10 x 1-VZ-SK-SW 11	20	5,5	14
15 214	Hydraulic grease nipple H3-90°	M 10 x 1,25-VZ-SK-SW 11	20	5,5	14
15 215 140	Hydraulic grease nipple H3-90°	M 10 x 1,5-VZ-SK-SW 11	20	5,5	14
15 237 140	Hydraulic grease nipple H3-90°	G 1/8"-VZ-SK-SW 11	20	5,5	14
15 226	Hydraulic grease nipple H3-90°	1/8" NPT-VZ-SK-SW 11	20	5,5	14
15 217	Hydraulic grease nipple H3-90°	M 12 x 1,5-VZ-SK-SW 14	22	6,5	14
15 218	Hydraulic grease nipple H3-90°	M 12 x 1,75-VZ-SK-SW 14	22	6,5	14
15 238	Hydraulic grease nipple H3-90°	G 1/4"-VZ-SK-SW 14	22	6,5	14
15 227	Hydraulic grease nipple H3-90°	1/4" NPT-VZ-SK-SW 14	22	6,5	14
15 239	Hydraulic grease nipple H3-90°	G 3/8"-VZ-SK-SW 17	20	7	19

Abbreviations

BSF	British standard fine/Whitworth thread, quality: fine
DIN	German Institute for Standardisation (DIN standards)
G	Whitworth Pipe Thread, cylindrical, ISO 228 (DIN 259)
H3	Hydraulic grease nipple, 180°, straight
M	Metric thread, cylindrical, DIN 13
NPT	National Taper Pipe, non-sealing and pressure-resistant tapered pipe thread
R	Whitworth thread, tapered, similar to DIN 3858, self-sealing connection
SK	Hexagon
SW	Wrench size
UNF	Unified Fine Thread
VA	Stainless steel
VK	Square
VZ	Galvanized

Hydraulic grease nipples H3, 90°, acc to DIN 71 412, stainless steel, rustproof, hexagon version



15 967

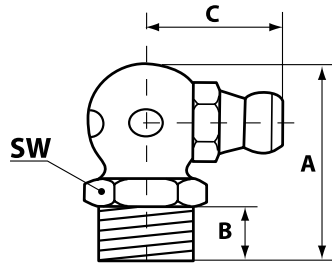

TECHNICAL DATA

- Norm: DIN 71 412
- Material: Stainless steel

SPECIFICATION

- Hexagon (SK)

PACKAGING

- Packing unit: 10

PRODUCTS

Item-No.	Description 1	Description 2	A	B	C
15 967	Hydraulic grease nipple H3-90°	M 6 x 1-VA-SK-SW 9	18	5,5	13
15 968	Hydraulic grease nipple H3-90°	M 8 x 1-VA-SK-SW 9	18	5,5	13
15 970	Hydraulic grease nipple H3-90°	M 8 x 1,25-VA-SK-SW 9	18	5,5	13
15 973	Hydraulic grease nipple H3-90°	M 10 x 1-VA-SK-SW 11	20	5,5	14
15 975	Hydraulic grease nipple H3-90°	M 10 x 1,5-VA-SK-SW 11	20	5,5	14
15 976	Hydraulic grease nipple H3-90°	R 1/8"-VA-SK-SW 11	20	5,5	14
15 977	Hydraulic grease nipple H3-90°	G 1/4"-VA-SK-SW 14	22	6,5	16

Hydraulic grease nipples H3, 90°, acc to DIN 71 412, hardened, galvanized, square version

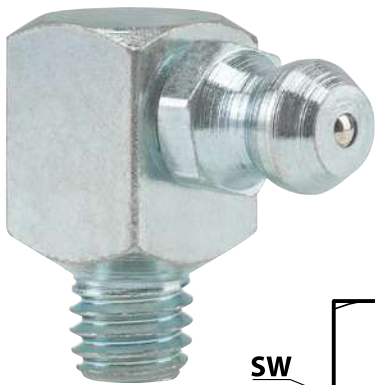

15 207

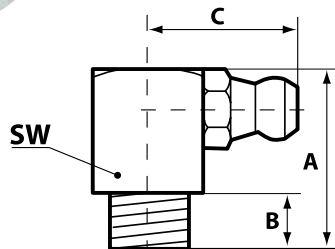

TECHNICAL DATA

- Norm: DIN 71 412
- Material: steel
- Surface: blue galvanized, hardened
- Surface hardness: 550 HV 1

SPECIFICATION

- Square (VK)

PACKAGING

- Packing unit: 100

PRODUCTS

Item-No.	Description 1	Description 2	A	B	C
15 207	Hydraulic grease nipple H3-90°	M 6 x 1-VZ-VK-SW 9	18	5,5	14
15 209	Hydraulic grease nipple H3-90°	M 8 x 1-VZ-VK-SW 9	18	5,5	14
15 210	Hydraulic grease nipple H3-90°	M 8 x 1,25-VZ-VK-SW 9	18	5,5	14
15 262	Hydraulic grease nipple H3-90°	1/4" UNF-VZ-VK-SW 9	18	5,5	14
15 200	Hydraulic grease nipple H3-90°	1/4" BSF-VZ-VK-SW 9	18	5,5	14
15 213	Hydraulic grease nipple H3-90°	M 10 x 1-VZ-VK-SW 11	18	5,5	15
15 215	Hydraulic grease nipple H3-90°	M 10 x 1,5-VZ-VK-SW 11	18	5,5	15
15 237	Hydraulic grease nipple H3-90°	G 1/8"-VZ-VK-SW 11	18	5,5	15

GREASE NIPPLES

Hydraulic grease nipples H3, 90°, acc to DIN 71 412, hardened, galvanized, self-tapping thread, VK



15 271

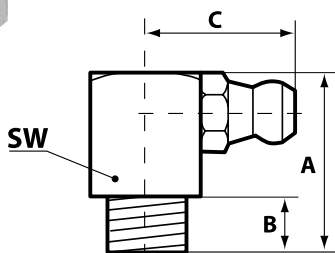

TECHNICAL DATA

- Norm: DIN 71 412
- Material: steel
- Surface: blue galvanized, hardened
- Surface hardness: 550 HV 1

SPECIFICATION

- Self-forming thread (SFG)
- Square (VK)

PACKAGING

- Packing unit: 100

PRODUCTS

Item-No.	Description 1	Description 2	A	B	C
15 271	Hydraulic grease nipple H3-90°	F 6 x 1-SFG-VZ-VK-SW 9	18	6	14
15 272	Hydraulic grease nipple H3-90°	F 8 x 1-SFG-VZ-VK-SW 9	18	6	14
15 273	Hydraulic grease nipple H3-90°	F 10 x 1-SFG-VZ-VK-SW 11	18	6	14

Hydraulic grease nipples H3 A, 90°, acc to DIN 71 412, hardened, galvanized, drive fit version

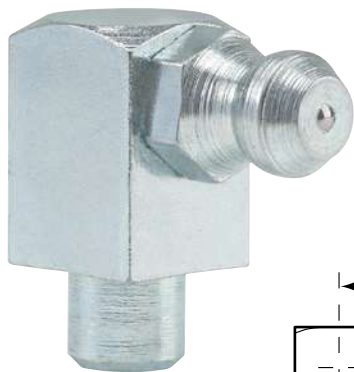

15 203

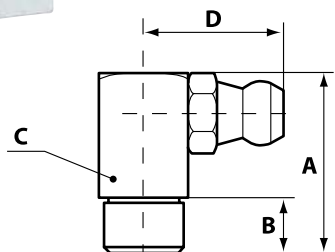

TECHNICAL DATA

- Norm: DIN 71 412
- Material: steel
- Surface: blue galvanized, hardened
- Surface hardness: 550 HV 1

SPECIFICATION

- Drive fit nipple (ESN)
- Square (VK)

PACKAGING

- Packing unit: 100

PRODUCTS

Item-No.	Description 1	Description 2	A	B	C	D
15 203	Hydraulic grease nipple H3 A-90°	Ø 6 mm-VZ-VK-ESN	18	5,5	9	9
15 204	Hydraulic grease nipple H3 A-90°	Ø 8 mm-VZ-VK-ESN	18	5,5	9	14,1
15 205	Hydraulic grease nipple H3 A-90°	Ø 10 mm-VZ-VK-ESN	18	5,5	11	15

Protective caps for hydraulic grease nipples



63 905

TECHNICAL DATA

- Material: polyethylene
- Colour: red

PACKAGING

- Packing unit: 100

PRODUCTS

Item-No.	Description 1	Description 2
63 905	Protecting cap with fixing tab	for hydraulic grease nipples
63 906	Protecting cap	for hydraulic grease nipples

Ball type grease nipples K1, galvanized, hexagon version



15 307

TECHNICAL DATA

- Material: steel
- Surface: blue galvanized

SPECIFICATION

- Hexagon (SK)

PACKAGING

- Packing unit: 100

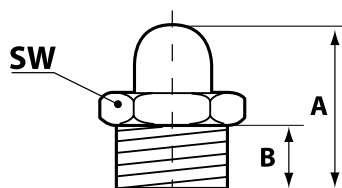

PRODUCTS

Item-No.	Description 1	Description 2	A	B
15 307	Ball type grease nipple K1	M 6 x 1-VZ-SK-SW 7	14	5,5
15 309	Ball type grease nipple K1	M 8 x 1-VZ-SK-SW 9	14	5,5
15 310	Ball type grease nipple K1	M 8 x 1,25-VZ-SK-SW 9	14	5,5
15 313	Ball type grease nipple K1	M 10 x 1-VZ-SK-SW 11	14	5,5
15 315	Ball type grease nipple K1	M 10 x 1,5-VZ-SK-SW 11	16	7

Abbreviations

ESN	Drive fit nipple	SFG	Self-forming thread
H3	Hydraulic grease nipple, 90°	SW	Wrench size
K1	Ball type grease nipple, 180°, straight	VK	Square
M	Metric thread, cylindrical, DIN 13	VZ	Galvanized

GREASE NIPPLES

Ball type grease nipples K1, galvanized, drive fit version



15 302

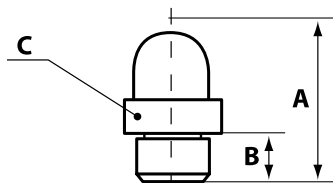

TECHNICAL DATA

- Material: steel
- Surface: blue galvanized

SPECIFICATION

- Drive fit nipple (ESN)

PACKAGING

- Packing unit: 100

PRODUCTS

Item-No.	Description 1	Description 2	A	B	C
15 302	Ball type grease nipple K1 A	Ø 5 mm-VZ-round-ESN	12	5	8
15 303	Ball type grease nipple K1 A	Ø 6 mm-VZ-round-ESN	12	6	8
15 304	Ball type grease nipple K1 A	Ø 8 mm-VZ-round-ESN	14	6	10

Funnel type grease nipples D1, acc to DIN 3405, galvanized, hexagon version



15 607

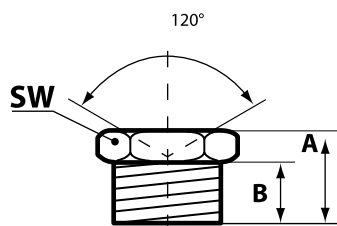

TECHNICAL DATA

- Material: steel
- Surface: blue galvanized

SPECIFICATION

- Hexagon (SK)

PACKAGING

- Packing unit: 100

PRODUCTS

Item-No.	Description 1	Description 2	A	B
15 607	Funnel type grease nipple D1	M 6 x 1-VZ-SK-SW 7	9	6
15 609	Funnel type grease nipple D1	M 8 x 1-VZ-SK-SW 9	9,5	6,5
15 610	Funnel type grease nipple D1	M 8 x 1,25-VZ-SK-SW 9	9,5	6,5
15 613	Funnel type grease nipple D1	M 10 x 1-VZ-SK-SW 11	9,5	6,5
15 615	Funnel type grease nipple D1	M 10 x 1,5-VZ-SK-SW 11	9,5	6,5
15 637	Funnel type grease nipple D1	G 1/8"-VZ-SK-SW 11	9,5	6,5
15 638	Funnel type grease nipple D1	G 1/4"-VZ-SK-SW 14	14	9,5
15 639	Funnel type grease nipple D1	G 3/8"-VZ-SK-SW 17	14,5	9

Funnel type grease nipples D1, acc to DIN 3405, brass, hexagon version



56 307

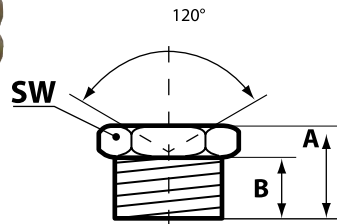

- TECHNICAL DATA**
- Norm: DIN 3405
 - Material: brass

- SPECIFICATION**
- Hexagon (SK)

- PACKAGING**
- Packing unit: 100

PRODUCTS

Item-No.	Description 1	Description 2	A	B
56 307	Funnel type grease nipple D1	M 6 x 1-Me-SK-SW 8	9	6
56 309	Funnel type grease nipple D1	M 8 x 1-Me-SK-SW 9	9,5	6,5
56 310	Funnel type grease nipple D1	M 8 x 1,25-Me-SK-SW 9	9,5	6,5
56 313	Funnel type grease nipple D1	M 10 x 1-Me-SK-SW 11	9,5	6,5
56 315	Funnel type grease nipple D1	M 10 x 1,5-Me-SK-SW 11	9,5	6,5
56 337	Funnel type grease nipple D1	G 1/8" -Me-SK-SW 11	9,5	6,5
56 338	Funnel type grease nipple D1	G 1/4" -Me-SK-SW 11	14	9,5

Funnel type grease nipples D1 A, acc to DIN 3405, galvanized, drive fit version



15 603

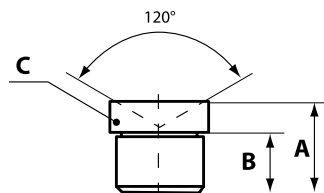

- TECHNICAL DATA**
- Material: steel
 - Surface: blue galvanized

- SPECIFICATION**
- Drive fit nipple (ESN)

- PACKAGING**
- Packing unit: 100

PRODUCTS

Item-No.	Description 1	Description 2	A	B	C
15 601	Funnel type grease nipple D1 A	4/5-Ø 4-KØ 5-VZ-round-ESN	6	4,5	5
15 602	Funnel type grease nipple D1 A	5/8-Ø 5-KØ 8-VZ-round-ESN	7,5	5,5	8
15 603	Funnel type grease nipple D1 A	6/8-Ø 6-KØ 8-VZ-round-ESN	7,5	5,5	8
15 604	Funnel type grease nipple D1 A	8/10-Ø 8-KØ 10-VZ-round-ESN	9,5	6,5	10
15 605	Funnel type grease nipple D1 A	10/12-Ø 10-KØ 12-VZ-round-ESN	9,5	6,5	12

GREASE NIPPLES

Funnel type grease nipples D1 A, acc to DIN 3405, brass, drive fit version



56 501

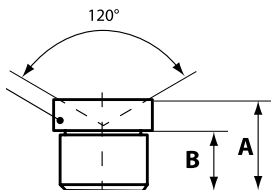

TECHNICAL DATA

- Norm: DIN 3405
- Material: brass

SPECIFICATION

- Drive fit nipple (ESN)

PACKAGING

- Packing unit: 100

PRODUCTS

Item-No.	Description 1	Description 2	A	B	C
56 501	Funnel type grease nipple D1 A	4/5-Ø 4-KØ 5-Me-round-ESN	6	4,5	5
56 502	Funnel type grease nipple D1 A	5/8-Ø 5-KØ 8-Me-round-ESN	6	4,5	5
56 503	Funnel type grease nipple D1 A	6/8-Ø 6-KØ 8-Me-round-ESN	7,5	5,5	8
56 504	Funnel type grease nipple D1 A	8/10-Ø 8-KØ 10-Me-round-ESN	9,5	6,5	10
56 505	Funnel type grease nipple D1 A	10/12-Ø 10-KØ 12-Me-round-ESN	9,5	6,5	12

Funnel type grease nipples D2, angled 45°, acc to DIN 3405, galvanized, square/hexagon version



15 707

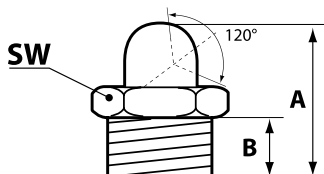

TECHNICAL DATA

- Norm: DIN 3405
- Material: steel
- Surface: blue galvanized

SPECIFICATION

- Hexagon (SK)
- Square (VK)

PACKAGING

- Packing unit: 100

PRODUCTS

Item-No.	Description 1	Description 2	A	B
15 707	Funnel type grease nipple D2-45°	M 6 x 1-VZ-VK-SW 9	16	5,5
15 709	Funnel type grease nipple D2-45°	M 8 x 1-VZ-SK-SW 11	16	5,5
15 710	Funnel type grease nipple D2-45°	M 8 x 1,25-VZ-SK-SW 11	16	5,5
15 713	Funnel type grease nipple D2-45°	M 10 x 1-VZ-SK-SW 11	15	5,5
15 715	Funnel type grease nipple D2-45°	M 10 x 1,5-VZ-SK-SW 11	15	5,5
15 737	Funnel type grease nipple D2-45°	G 1/8" -VZ-SK-SW 11	15	5,5
15 738	Funnel type grease nipple D2-45°	G 1/4" -VZ-SK-SW 14	18	6,5
15 739	Funnel type grease nipple D2-45°	G 3/8" -VZ-SK-SW 17	22	9

Funnel type grease nipples D2, angled 45°, acc to DIN 3405, brass, hexagon version



56 707

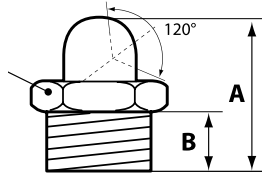

TECHNICAL DATA

- Norm: DIN 3405
- Material: brass

SPECIFICATION

- Hexagon (SK)

PACKAGING

- Packing unit: 100

PRODUCTS

Item-No.	Description 1	Description 2	A	B
56 707	Funnel type grease nipple D2-45°	M 6 x 1-Me-SK-SW 11	16	5,5
56 709	Funnel type grease nipple D2-45°	M 8 x 1-Me-SK-SW 11	16	5,5
56 710	Funnel type grease nipple D2-45°	M 8 x 1,25-Me-SK-SW 11	16	5,5
56 713	Funnel type grease nipple D2-45°	M 10 x 1-Me-SK-SW 11	15	5,5
56 715	Funnel type grease nipple D2-45°	M 10 x 1,5-Me-SK-SW 11	15	5,5
56 737	Funnel type grease nipple D2-45°	G 1/8" -Me-SK-SW 11	15	5,5
56 738	Funnel type grease nipple D2-45°	G 1/4" -Me-SK-SW 11	18	6,5

Funnel type grease nipples D3, angled 90°, acc to DIN 3405, galvanized, square/hexagon version



15 807

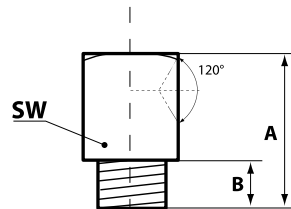

TECHNICAL DATA

- Norm: DIN 3405
- Material: steel
- Surface: blue galvanized

SPECIFICATION

- Hexagon (SK)
- Square (VK)

PACKAGING

- Packing unit: 100

PRODUCTS

Item-No.	Description 1	Description 2	A	B
15 807	Funnel type grease nipple D3-90°	M 6 x 1-VZ-SK-SW 11	18	5,5
15 809	Funnel type grease nipple D3-90°	M 8 x 1-VZ-VK-SW 9	18	5,5
15 810	Funnel type grease nipple D3-90°	M 8 x 1,25-VZ-SK-SW 11	18	5,5
15 813	Funnel type grease nipple D3-90°	M 10 x 1-VZ-SK-SW 11	18	5,5
15 815	Funnel type grease nipple D3-90°	M 10 x 1,5-VZ-SK-SW 11	18	5,5
15 837	Funnel type grease nipple D3-90°	G 1/8" -VZ-SK-SW 11	18	5,5
15 838	Funnel type grease nipple D3-90°	G 1/4" -VZ-SK-SW 14	20	6,5
15 839	Funnel type grease nipple D3-90°	G 3/8" -VZ-SK-SW 17	25	9

GREASE NIPPLES

Funnel type grease nipples D3, angled 90°, acc to DIN 3405, brass, hexagon version



56 907

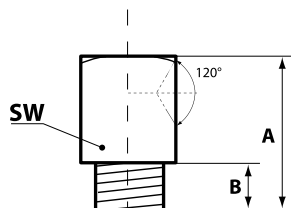

TECHNICAL DATA

- Norm: DIN 3405
- Material: brass

SPECIFICATION

- Hexagon (SK)

PACKAGING

- Packing unit: 100

PRODUCTS

Item-No.	Description 1	Description 2	A	B
56 907	Funnel type grease nipple D3-90°	M 6 x 1-Me-SK-SW 11	18	5,5
56 909	Funnel type grease nipple D3-90°	M 8 x 1-Me-SK-SW 11	18	5,5
56 910	Funnel type grease nipple D3-90°	M 8 x 1,25-Me-SK-SW 11	18	5,5
56 913	Funnel type grease nipple D3-90°	M 10 x 1-Me-SK-SW 11	18	5,5
56 915	Funnel type grease nipple D3-90°	M 10 x 1,5-Me-SK-SW 11	18	5,5
56 937	Funnel type grease nipple D3-90°	G 1/8" -Me-SK-SW 11	18	5,5
56 938	Funnel type grease nipple D3-90°	G 1/4" -Me-SK-SW 17	20	6,5

Button head grease nipples M1, head diameter 16 mm, acc to DIN 3404, galvanized, hexagon version, RK



57 807

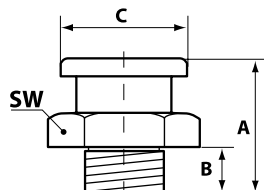

TECHNICAL DATA

- Norm: DIN 3404
- Material: steel
- Surface: blue galvanized

SPECIFICATION

- Hexagon (SK)
- Round head (RK)

PACKAGING

- Packing unit: 50

PRODUCTS

Item-No.	Description 1	Description 2	A	B	C
57 807	Button head grease nipple M1-KØ 16	M 6 x 1-VZ-SK-SW 17-RK	17	6	16
57 809	Button head grease nipple M1-KØ 16	M 8 x 1-VZ-SK-SW 17-RK	17	6	16
57 810	Button head grease nipple M1-KØ 16	M 8 x 1,25-VZ-SK-SW 17-RK	17	6	16
57 813	Button head grease nipple M1-KØ 16	M 10 x 1-VZ-SK-SW 17-RK	17	6	16
57 815	Button head grease nipple M1-KØ 16	M 10 x 1,5-VZ-SK-SW 17-RK	17	6	16
57 817	Button head grease nipple M1-KØ 16	M 12 x 1,5-VZ-SK-SW 17-RK	17	6	16
57 818	Button head grease nipple M1-KØ 16	M 12 x 1,75-VZ-SK-SW 17-RK	17	6	16
57 823	Button head grease nipple M1-KØ 16	M 16 x 1,5-VZ-SK-SW 17-RK	18	7	16
57 837	Button head grease nipple M1-KØ 16	G 1/8"-VZ-SK-SW 17-RK	17	6	16
57 838	Button head grease nipple M1-KØ 16	G 1/4"-VZ-SK-SW 17-RK	17	6	16

Button head grease nipples M1, head diameter 16 mm, acc to DIN 3404, stainless steel, hexagon version, RK



55 907

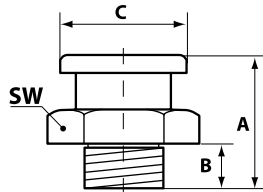

TECHNICAL DATA

- Norm: DIN 3404
- Material: Stainless steel

SPECIFICATION

- Hexagon (SK)
- Round head (RK)

PACKAGING

- Packing unit: 10

PRODUCTS

Item-No.	Description 1	Description 2	A	B	C
55 907	Button head grease nipple M1-KØ 16	M 6 x 1-VA-SK-SW 17-RK	17	6	16
55 909	Button head grease nipple M1-KØ 16	M 8 x 1-VA-SK-SW 17-RK	17	6	16
55 910	Button head grease nipple M1-KØ 16	M 8 x 1,25-VA-SK-SW 17-RK	17	6	16
55 913	Button head grease nipple M1-KØ 16	M 10 x 1-VA-SK-SW 17-RK	17	6	16
55 915	Button head grease nipple M1-KØ 16	M 10 x 1,5-VA-SK-SW 17-RK	17	6	16
55 918	Button head grease nipple M1-KØ 16	M 12 x 1,75-VA-SK-SW 17-RK	17	6	16
55 937	Button head grease nipple M1-KØ 16	G 1/8" -VA-SK-SW 17-RK	17	6	16
55 938	Button head grease nipple M1-KØ 16	G 1/4" -VA-SK-SW 17-RK	17	6	16

Button head grease nipple M22, head diameter 22 mm, acc to DIN 3404, galvanized, hexagon version, RK



57 607

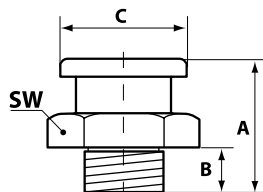

TECHNICAL DATA

- Norm: DIN 3404
- Material: steel
- Surface: blue galvanized

SPECIFICATION

- Hexagon (SK)
- Round head (RK)

PACKAGING

- Packing unit: 50

PRODUCTS

Item-No.	Description 1	Description 2	A	B	C
57 607	Button head grease nipple M4-KØ 10	M 6 x 1-VZ-SK-SW 11-RK	13,5	6	10
57 609	Button head grease nipple M4-KØ 10	M 8 x 1-VZ-SK-SW 11-RK	13,5	6	10
57 610	Button head grease nipple M4-KØ 10	M 8 x 1,25-VZ-SK-SW 11-RK	13,5	6	10
57 613	Button head grease nipple M4-KØ 10	M 10 x 1-VZ-SK-SW 11-RK	13,5	6	10
57 637	Button head grease nipple M4-KØ 10	G 1/8" -VZ-SK-SW 11-RK	13,5	6	10

GREASE NIPPLES

Button head grease nipples M22, diameter of head 22 mm, acc. to DIN 3404, galvanized, hexagon version, RK



57 523

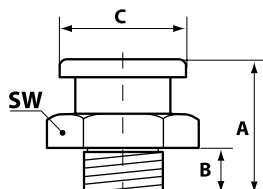

TECHNICAL DATA

- Norm: DIN 3404
- Material: steel
- Surface: blue galvanized

SPECIFICATION

- Hexagon (SK)
- Round head (RK)

PACKAGING

- Packing unit: 50

PRODUCTS

Item-No.	Description 1	Description 2	A	B	C
57 523	Button head grease nipple M22-KØ 22	M 16 x 1,5-VZ-SK-SW 22-RK	21,5	8	22
57 538	Button head grease nipple M22-KØ 22	G 1/4"-VZ-SK-SW 22-RK	21,5	8	22
57 539	Button head grease nipple M22-KØ 22	G 3/8"-VZ-SK-SW 22-RK	21,5	8	22
57 522	Button head grease nipple M22-KØ 22	M 16 x 1,5-VZ-SK-SW 22-RK-STV	32	12	22

Button head grease nipple T1/B, head diameter 16 mm, galvanized, hexagon version, hexagon head



55 807

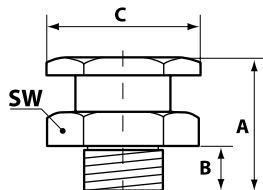

TECHNICAL DATA

- Norm: DIN 3404
- Material: steel
- Surface: blue galvanized

SPECIFICATION

- Hexagon (SK)
- Hexagon head (SKK)

PACKAGING

- Packing unit: 50

PRODUCTS

Item-No.	Description 1	Description 2	A	B	C
55 807	Button head grease nipple T1/B-KØ 16	M 6 x 1-VZ-SK-SW 15-SKK	16	6	16,5
55 809	Button head grease nipple T1/B-KØ 16	M 8 x 1-VZ-SK-SW 15-SKK	16	6	16,5
55 810	Button head grease nipple T1/B-KØ 16	M 8 x 1,25-VZ-SK-SW 15-SKK	16	6	16,5
55 813	Button head grease nipple T1/B-KØ 16	M 10 x 1-VZ-SK-SW 15-SKK	16	6	16,5
55 815	Button head grease nipple T1/B-KØ 16	M 10 x 1,5-VZ-SK-SW 15-SKK	16	6	16,5
55 817	Button head grease nipple T1/B-KØ 16	M 12 x 1,5-VZ-SK-SW 15-SKK	16	6	16,5
55 837	Button head grease nipple T1/B-KØ 16	G 1/8"-VZ-SK-SW 15-SKK	16	6	16,5
55 838	Button head grease nipple T1/B-KØ 16	G 1/4"-VZ-SK-SW 15-SKK	16	6	16,5

Button head grease nipple T1/B, head diameter 16 mm, brass, hexagon version, hexagon head

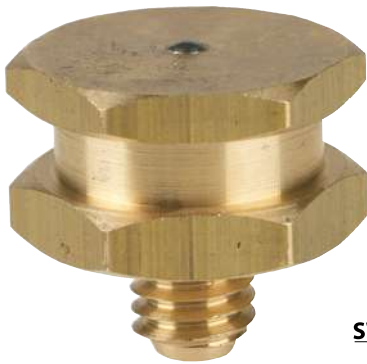

55 707

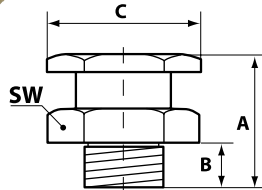

TECHNICAL DATA

- Norm: DIN 3404
- Material: brass

SPECIFICATION

- Hexagon (SK)
- Hexagon head (SKK)

PACKAGING

- Packing unit: 50

PRODUCTS

Item-No.	Description 1	Description 2	A	B	C
55 707	Button head grease nipple T1/B-KØ 16	M 6 x 1-Me-SK-SW 15-SKK	16	6	16,5
55 709	Button head grease nipple T1/B-KØ 16	M 8 x 1-Me-SK-SW 15-SKK	16	6	16,5
55 710	Button head grease nipple T1/B-KØ 16	M 8 x 1,25-Me-SK-SW 15-SKK	16	6	16,5
55 713	Button head grease nipple T1/B-KØ 16	M 10 x 1-Me-SK-SW 15-SKK	16	6	16,5
55 715	Button head grease nipple T1/B-KØ 16	M 10 x 1,5-Me-SK-SW 15-SKK	16	6	16,5
55 716	Button head grease nipple T1/B-KØ 16	M 12 x 1-Me-SK-SW 15-SKK	16	6	16,5
55 717	Button head grease nipple T1/B-KØ 16	M 12 x 1,5-Me-SK-SW 15-SKK	16	6	16,5
55 718	Button head grease nipple T1/B-KØ 16	M 12 x 1,75-Me-SK-SW 15-SKK	16	6	16,5
55 722	Button head grease nipple T1/B-KØ 16	M 14 x 2-Me-SK-SW 15-SKK	16	6	16,5
55 737	Button head grease nipple T1/B-KØ 16	G 1/8" -Me-SK-SW 15-SKK	16	6	16,5
55 738	Button head grease nipple T1/B-KØ 16	G 1/4" -Me-SK-SW 15-SKK	16	6	16,5
55 739	Button head grease nipple T1/B-KØ 16	G 3/8" -Me-SK-SW 15-SKK	16	6	16,5

Button head grease nipple T1/B, head diameter 16 mm, brass, stainless steel ball, hexagon version, SKK



57 907

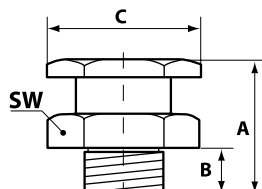

TECHNICAL DATA

- Norm: DIN 3404
- Material: brass
- Material ball: Stainless steel

SPECIFICATION

- Hexagon (SK)
- Hexagon head (SKK)

PACKAGING

- Packing unit: 10

PRODUCTS

Item-No.	Description 1	Description 2	A	B	C
57 907	Button head grease nipple T1/B-KØ 16	M 6 x 1-Me-VA-SK-SW 15-SKK	16	6	6,5
57 910	Button head grease nipple T1/B-KØ 16	M 8 x 1,25-Me-VA-SK-SW 15-SKK	16	6	6,5
57 913	Button head grease nipple T1/B-KØ 16	M 10 x 1-Me-VA-SK-SW 15-SKK	16	6	6,5
57 915	Button head grease nipple T1/B-KØ 16	M 10 x 1,5-Me-VA-SK-SW 15-SKK	16	6	6,5
57 918	Button head grease nipple T1/B-KØ 16	M 12 x 1,5-Me-VA-SK-SW 15-SKK	16	6	6,5
57 937	Button head grease nipple T1/B-KØ 16	G 1/8" -Me-VA-SK-SW 15-SKK	16	6	6,5

GREASE NIPPLES

Grease nipple assortments







16 099

PACKAGING

- Packing unit: 1

PRODUCTS

Figure	Item-No.	Description 1	Description 2
	16 090	Grease nipple assortment	140 pcs.
	16 091	Grease nipple assortment	180 pcs.
	16 092	Grease nipple assortment	70 pcs.
	16 099	Grease nipple assortment	387 pcs.

Grease nipple tools



16 100

TECHNICAL DATA

- Material: steel, galvanized

PACKAGING

- Packing unit: 1

PRODUCTS

Item-No.	Description 1	Description 2	SW 8 + 9	SW 10 + 11
16 100	Tool for grease nipples	1/8" PTF-H1-H2-H3-K1-K2-K3	×	
16 102	Tool for grease nipples	1/4" UNF-H1-H2-H3-K1-K2-K3		×

Grease nipples H1, H1 A, straight, 180°, 25 pcs. in polybag



16 007

SPECIFICATION

- Polybag, blank, with EAN bar code

PACKAGING

- Packing unit: 25

PRODUCTS

Item-No.	Description 1	Description 2
16 007	Hydraulic grease nipple H1-straight	M 6 x 1-VZ-SK-SW 7-25 pcs.
16 009	Hydraulic grease nipple H1-straight	M 8 x 1-VZ-SK-SW 9-25 pcs.
16 010	Hydraulic grease nipple H1-straight	M 8 x 1,25-VZ-SK-SW 9-25 pcs.
16 013	Hydraulic grease nipple H1-straight	M 10 x 1-VZ-SK-SW 11-25 pcs.
16 015	Hydraulic grease nipple H1-straight	M 10 x 1,5-VZ-SK-SW 11-25 pcs.
16 037	Hydraulic grease nipple H1-straight	G 1/8" -VZ-SK-SW 11-25 pcs.
16 038	Hydraulic grease nipple H1-straight	G 1/4" -VZ-SK-SW 14-25 pcs.
16 062	Hydraulic grease nipple H1-straight	1/4" -UNF-VZ-SK-SW 7-25 pcs.
16 003	Hydraulic grease nipple H1 A-straight	Ø 6 mm-VZ-ESN-25 pcs.
16 004	Hydraulic grease nipple H1 A-straight	Ø 8 mm-VZ-ESN-25 pcs.

Grease nipples H2, H2 A, 45°, 25 pcs. in polybag



16 103

SPECIFICATION

- Polybag, blank, with EAN bar code

PACKAGING

- Packing unit: 25

PRODUCTS

Item-No.	Description 1	Description 2
16 107	Hydraulic grease nipple H2-45°	M 6 x 1-VZ-VK-SW 9-25 pcs.
16 109	Hydraulic grease nipple H2-45°	M 8 x 1-VZ-VK-SW 9-25 pcs.
16 110	Hydraulic grease nipple H2-45°	M 8 x 1,25-VZ-VK-SW 9-25 pcs.
16 113	Hydraulic grease nipple H2-45°	M 10 x 1-VZ-VK-SW 11-25 pcs.
16 115	Hydraulic grease nipple H2-45°	M 10 x 1,5-VZ-VK-SW 11-25 pcs.
16 137	Hydraulic grease nipple H2-45°	G 1/8" -VZ-VK-SW 11-25 pcs.
16 138	Hydraulic grease nipple H2-45°	G 1/4" -VZ-SK-SW 14-25 pcs.
16 103	Hydraulic grease nipple H2 A-45°	Ø 6 mm-VZ-ESN-25 pcs.
16 104	Hydraulic grease nipple H2 A-45°	Ø 8 mm-VZ-ESN-25 pcs.

GREASE NIPPLES

Grease nipples H3, H3 A, 90°, 25 pcs in polybag



SPECIFICATION

- Polybag, blank, with EAN bar code

PACKAGING

- Packing unit: 25

PRODUCTS

16 203

Item-No.	Description 1	Description 2
16 207	Hydraulic grease nipple H3-90°	M 6 x 1-VZ-VK-SW 9-25 pcs.
16 209	Hydraulic grease nipple H3-90°	M 8 x 1-VZ-VK-SW 9-25 pcs.
16 211	Hydraulic grease nipple H3-90°	M 8 x 1,25-VZ-VK-SW 9-25 pcs.
16 213	Hydraulic grease nipple H3-90°	M 10 x 1-VZ-VK-SW 11-25 pcs.
16 215	Hydraulic grease nipple H3-90°	M 10 x 1,5-VZ-VK-SW 11-25 pcs.
16 237	Hydraulic grease nipple H3-90°	G 1/8" -VZ-VK-SW 11-25 pcs.
16 238	Hydraulic grease nipple H3-90°	G 1/4" -VZ-SK-SW 14-25 pcs.
16 203	Hydraulic grease nipple H3 A-90°	Ø 6 mm-VZ-ESN-25 pcs.
16 204	Hydraulic grease nipple H3 A-90°	Ø 8 mm-VZ-ESN-25 pcs.

Button head grease nipple M1, head diameter 16 mm, 25 pcs. in polybag



16 809

SPECIFICATION

- Polybag, blank, with EAN bar code

PACKAGING

- Packing unit: 25

PRODUCTS

Item-No.	Description 1	Description 2
16 809	Button head grease nipple M1-KØ 16	M 8 x 1-VZ-SK-SW 17-RK-25 pcs.
16 813	Button head grease nipple M1-KØ 16	M 10 x 1-VZ-SK-SW 17-RK-25 pcs.
16 837	Button head grease nipple M1-KØ 16	G 1/8" -VZ-SK-SW 17-RK-25 pcs.

Hydraulic grease nipples H1, straight, 180°, 10 pcs. in polybag with headcard



16 400

SPECIFICATION

- SB sales packing, with headcard and EAN bar code

PACKAGING

- Packing unit: 10

PRODUCTS

Item-No.	Description 1	Description 2
16 400	Hydraulic grease nipple H1-straight	M 6 x 1-VZ-SK-SW 7-10 pcs.
16 402	Hydraulic grease nipple H1-straight	M 8 x 1-VZ-SK-SW 9-10 pcs.
16 403	Hydraulic grease nipple H1-straight	M 8 x 1,25-VZ-SK-SW 9-10 pcs.
16 404	Hydraulic grease nipple H1-straight	M 10 x 1-VZ-SK-SW 11-10 pcs.
16 405	Hydraulic grease nipple H1-straight	M 10 x 1,5-VZ-SK-SW 11-10 pcs.
16 409	Hydraulic grease nipple H1-straight	G 1/8"-VZ-SK-SW 11-10 pcs.

Hydraulic grease nipples H2, 45°, 5 pcs. in polybag with headcard



16 430

SPECIFICATION

- SB sales packing, with headcard and EAN bar code

PACKAGING

- Packing unit: 10

PRODUCTS

Item-No.	Description 1	Description 2
16 430	Hydraulic grease nipple H2-45°	M 6 x 1-VZ-SK-SW 9-5 pcs.
16 432	Hydraulic grease nipple H2-45°	M 8 x 1-VZ-SK-SW 9-5 pcs.
16 433	Hydraulic grease nipple H2-45°	M 8 x 1,25-VZ-SK-SW 9-5 pcs.
16 434	Hydraulic grease nipple H2-45°	M 10 x 1-VZ-SK-SW 11-5 pcs.
16 435	Hydraulic grease nipple H2-45°	M 10 x 1,5-VZ-SK-SW 11-5 pcs.
16 439	Hydraulic grease nipple H2-45°	G 1/8"-VZ-SK-SW 11-5 pcs.

GREASE NIPPLES

Hydraulic grease nipples H3, 90°, 5 pcs. in polybag with headcard



16 460

SPECIFICATION

- SB sales packing, with headcard and EAN bar code

PACKAGING

- Packing unit: 10

PRODUCTS

Item-No.	Description 1	Description 2
16 460	Hydraulic grease nipple H3-90°	M 6 x 1-VZ-SK-SW 9-5 pcs.
16 462	Hydraulic grease nipple H3-90°	M 8 x 1-VZ-SK-SW 9-5 pcs.
16 463	Hydraulic grease nipple H3-90°	M 8 x 1,25-VZ-SK-SW 9-5 pcs.
16 464	Hydraulic grease nipple H3-90°	M 10 x 1-VZ-SK-SW 11-5 pcs.
16 465	Hydraulic grease nipple H3-90°	M 10 x 1,5-VZ-SK-SW 11-5 pcs.
16 469	Hydraulic grease nipple H3-90°	G 1/8"-VZ-SK-SW 11-5 pcs.

Hydraulic grease nipples H1 straight 180°, H2-45°, H3-90°, 5 pcs. each in polybag with headcard



16 476

SPECIFICATION

- SB sales packing, with headcard and EAN bar code

PACKAGING

- Packing unit: 10

PRODUCTS

Item-No.	Description 1	Description 2
16 476	Hydraulic grease nipple H1-H2-H3	M 6 x 1-VZ-SK/VK-SW 9-5 pcs.ea
16 478	Hydraulic grease nipple H1-H2-H3	M 8 x 1-VZ-SK/VK-SW 9-5 pcs.ea
16 480	Hydraulic grease nipple H1-H2-H3	M 10 x 1-VZ-SK/VK-SW 9-5 pcs.ea
16 482	Hydraulic grease nipple H1-H2-H3	G 1/8" -VZ-SK/VK-SW 9-5 pcs.ea