



**Manual 2D Vision Measuring Machines Quick Image**  
**Page 572**



**Manual 2.5D Vision Measuring Machines Quick Scope**  
**Page 574**



**3D CNC Vision Measuring Machines Quick Vision**  
**Page 576**



**3D CNC Multisensor Measuring Machines Quick Vision**  
**Page 582**



**3D CNC Multisensor Measuring Machines MiSCAN**  
**Page 584**



**3D CNC Measuring Machines for Micro Geometries**  
**Page 585**



**Software for Quick Vision Machines**  
**Page 587**



**Accessories for Vision Machines**  
**Page 588**

# Quick Image

## Quick Image

The ultimate in simple operation with **one click measurement**.

This non-contact 2D vision measuring system brings you a new concept in 2D vision measuring instruments. It offers several unique features to improve the efficiency of your measurements, including:

- Large depth of field and wide field of view.
- Double telecentric optical system.
- 3 megapixels colour camera.
- 4-quadrant LED ring light.
- Motorized stage models provide highest measurement efficiency.



QI-A/B



QI-C

### QI-A models, 0.2x Magnification, Manual stage

No.	Model	Travelling range X-, Y-axis [mm]	Travelling range Z-axis [mm]
361-850A	QI-A1010D	100 x 100	100
361-851A	QI-A2010D	200 x 100	100
361-852A	QI-A2017D	200 x 170	100
361-853A	QI-A3017D	300 x 170	100
361-854A	QI-A4020D	400 x 200	100

### QI-B models, 0.5x Magnification, Manual stage

No.	Model	Travelling range X-, Y-axis [mm]	Travelling range Z-axis [mm]
361-855A	QI-B1010D	100 x 100	100
361-856A	QI-B2010D	200 x 100	100
361-857A	QI-B2017D	200 x 170	100
361-858A	QI-B3017D	300 x 170	100
361-859A	QI-B4020D	400 x 200	100

### QI-C models, 0.2x Magnification, Motorized stage

No.	Model	Travelling range X-, Y-axis [mm]	Travelling range Z-axis [mm]
361-860-11	QI-C2010D	200 x 100	100
361-861-11	QI-C2017D	200 x 170	100
361-862-11	QI-C3017D	300 x 170	100

## Specifications

Measuring Mode	High-resolution mode and Normal mode
Optical system working distance	90 mm
Optical system depth of focus	<b>High-resolution mode :</b> ±0,6 mm (QI-A, QI-B and QI-C)  <b>Normal mode :</b> ±11 mm (QI-A and QI-C) ±1,8 mm (QI-B)
Accuracy <sup>(1)</sup>	$E_{1(x,y)} = \pm(3,5+0,02L) \mu\text{m}$ L = measured length (mm) <sup>(1)</sup> According to Mitutoyo inspection method
Optical system magnification	<b>QI-A and QI-C models :</b> 0,2X <b>QI-B models :</b> 0,5X
CCD camera	3 megapixels colour CCD camera
Illumination	- Contour: White LED - Coaxial: White LED - 4-quadrant white LED ring light

## Optional accessories

No.	Description
12AAJ088.	Reinforced footswitch

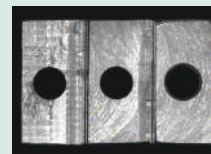

Image of a stepped block using the double telecentric objective showing the orthographic view produced.

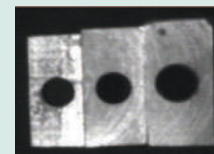

Image of the same object using a standard objective



Refer to the Quick Image brochure

# Software for Quick Image Systems

## Specifications

QIPAK  
Additional software (optional)

MEASURLINK  
(refer to the Measurlink page)  
QS CAD-IMPORT/EXPORT  
FORMTRACEPAK-AP<sup>(1)</sup>

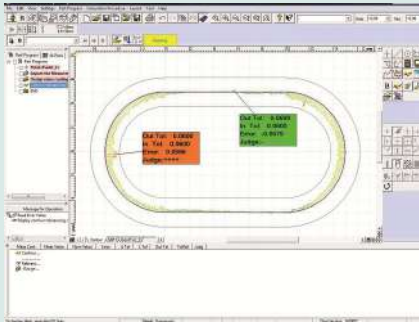

(1) FORMTRACEPAK-AP

Simple and easy-to-use 2D contour analysis.  
Graphic reports (geometry or scanning) edition.  
Allows measurement by comparison.  
For more information refer to FORMTRACEPAK-AP.

## QIPAK

- One click measurement with QUICK GO / NG decision
- Single mouse-click edge-detection tools; very easy to use.
- Template tools for comparative analysis.
- Video image capture.
- Stage navigation function gives improved measurement cycles.
- Image stitching provides wide area measurement.

No.	Type
QIPAK	Software for Quick Image Systems

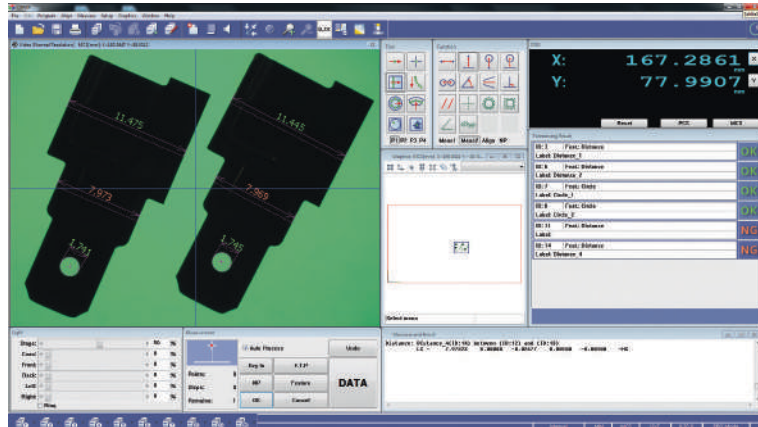

QIPAK screen layout in pro mode

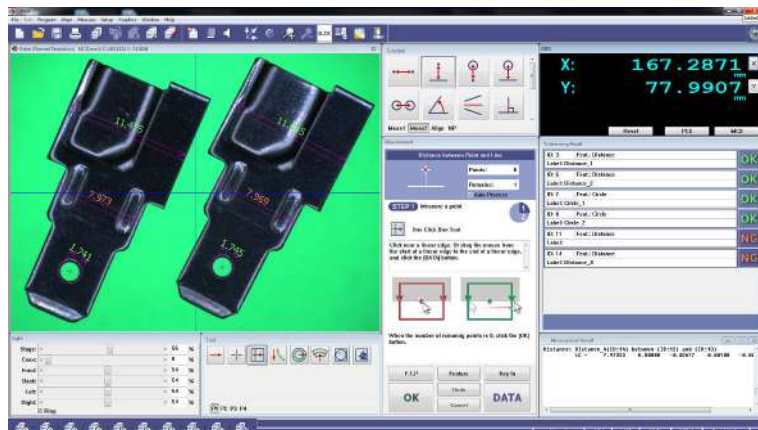

QIPAK screen layout in easy mode

# Manual Quick Scope QS-L

## Quick Scope

This manual vision measuring system is an excellent surface observation system which you can use on a wide variety of workpieces.

The Quick Scope offers you the following benefits:

- 0,1 µm resolution and 150 mm Z-axis range.
- Power zoom enabling you to change magnification change quickly and easily.
- Fine illumination capability enabling you to change lighting to match your workpiece requirements.
- A quick release system on the stage, so you can switch instantly between coarse and fine movement.
- Quick navigation function allowing you to repeat measurements quickly.
- Motorized Z-axis enables fast and accurate Auto Focus.

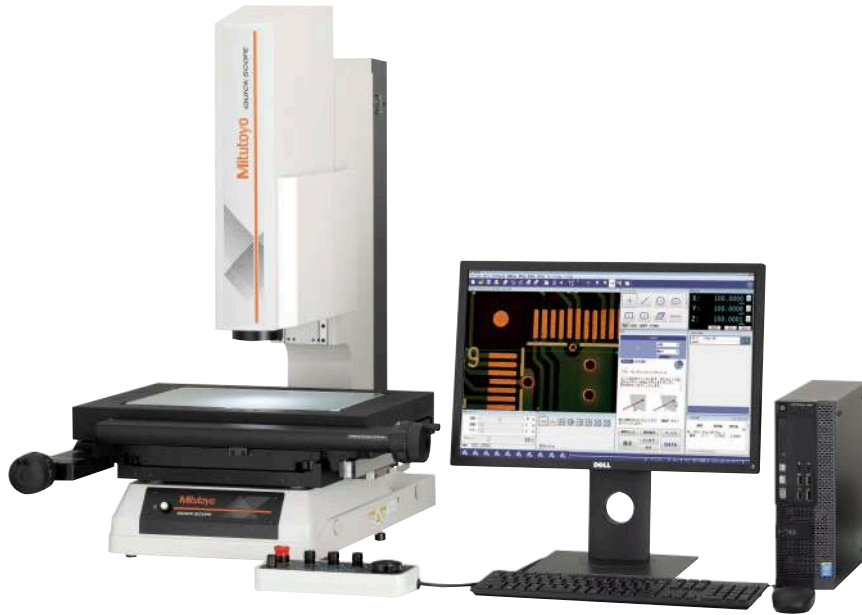

QS-L Z/AFC models

No.	Model	Travelling range X-, Y-axis [mm]	Travelling range Z-axis [mm]	Magnification (optical system)	Z-axis measurement	Max. stage loading
359-713-10	QS-L2010Z/AFC	200 x 100	150	0,75X -> 5,25X with 1,5X objective	Motorized with AF	10 kg
359-714-10	QS-L3017Z/AFC	300 x 170	150	0,75X -> 5,25X with 1,5X objective	Motorized with AF	20 kg
359-715-10	QS-L4020Z/AFC	400 x 200	150	0,75X -> 5,25X with 1,5X objective	Motorized with AF	15 kg

## Specifications

Accuracy<sup>(1)</sup>

$E_{1(x,y)} = (2,2 + 0,02L) \mu\text{m}$   
 $E_{1(z)} = (4,5 + 6L/1000) \mu\text{m}$   
 L = measured length (mm)  
<sup>(1)</sup>According to Mitutoyo inspection method

Illumination

- Contour: White LED  
 - Coaxial: White LED  
 - Ring Light: 4-quadrant White LED

## Optional accessories

No.	Description
937179T	Footswitch for SPC
12AAJ088	Footswitch

Refer to the Optical Accessories page for Quick Scope / Quick Vision for more information on calibration charts.



1X, 1.5X and 2X interchangeable lens



Quick Scope brochure on request

# Software for Quick Scope Systems

## Specifications

QIPAK  
Additional software (optional)

MEASURLINK  
(refer to the Measurlink page)

QS CAD-IMPORT/EXPORT

FORMTRACEPAK-AP<sup>(1)</sup>

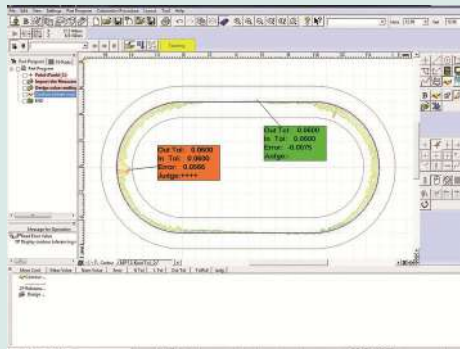

<sup>(1)</sup> FORMTRACEPAK-AP

Simple and easy-to-use 2D contour analysis.  
Graphic reports (geometry or scanning) edition.  
Allows measurement by comparison.  
For more information refer to FORMTRACEPAK-AP

## QSPAK

- Easy to use, single mouse-click edge-detection tools.
- Template tools for comparative analysis.
- Video image capture.
- Stage navigation function for CNC machines giving you improved measurement cycles.

No.	Type
QSPAK	Software for Quick Scope systems

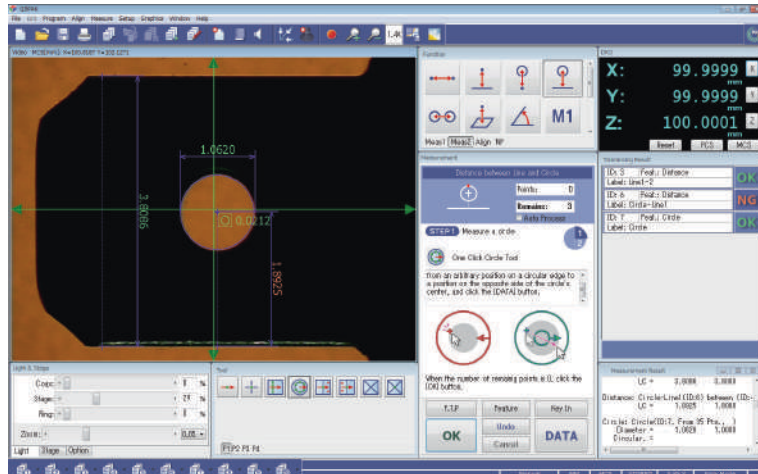

QSPAK Layout: Easy mode

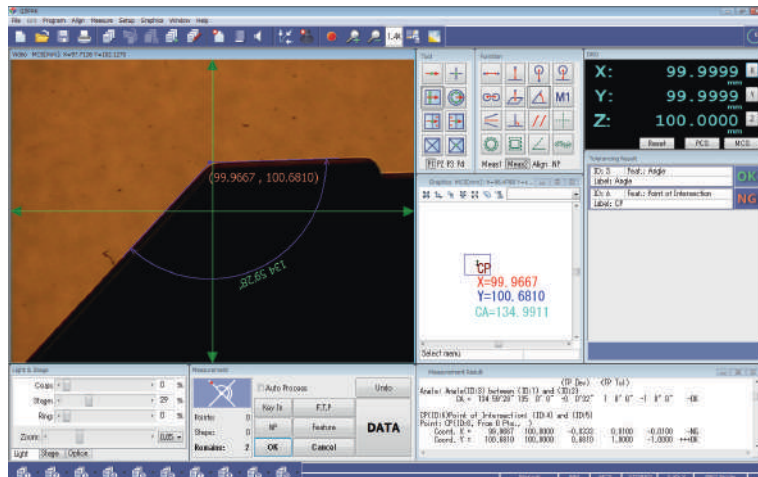

QSPAK Layout: Pro mode

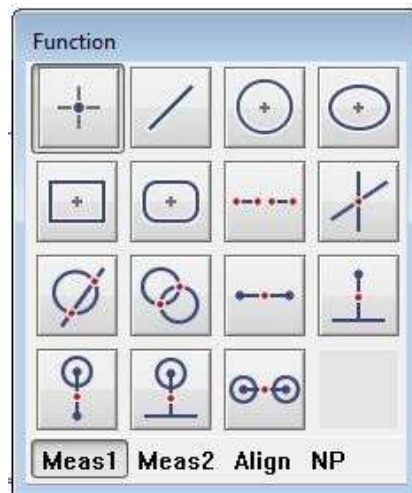

Measurement item commands

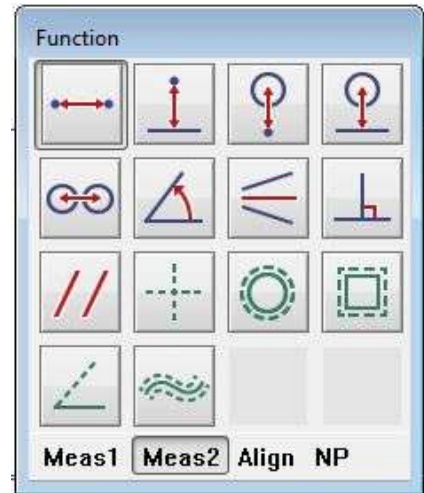



# Quick Vision ACTIVE

## Quick Vision ACTIVE

This CNC Vision Measuring System combines the flexibility of a high quality zoom lens with the speed of a state-of-the-art digital colour camera and offers the following benefits:

- Programmable LED stage- and coaxial-light.
- Programmable 4-quadrant LED ring light.
- High-resolution and high-speed CMOS colour camera.
- High-quality 7-step zoom optics with interchangeable lenses.
- Compact design.
- Powerful, user-friendly QVPAK software.
- Touch probe option.



QV ACTIVE 202



QV ACTIVE 404



No.	Model	Range (X, Y, Z-axis) with Vision Head	Measuring range (X×Y×Z)	Max. stage loading
363-109-30	QV-L202Z1L-D	250x200x150 mm	250x200x150 mm	10 kg
363-110-30	QV-L404Z1L-D	400x400x200 mm	400x400x200 mm	20 kg

## Specifications

Resolution	0,1 μm
Illumination	(White LED) <ul style="list-style-type: none"> <li>• Contour</li> <li>• Coaxial</li> <li>• 4-quadrant ring light</li> </ul>
Magnification change system	Zoom optical system with 8 positions Standard 1,5X magnification lens
Sensor type	High resolution CMOS colour camera
Additional objective lenses	1X and 2X magnification lenses

## Optional accessories

No.	Description
02ATN695.	Calibration chart with holder



1X, 1,5X and 2X interchangeable lens

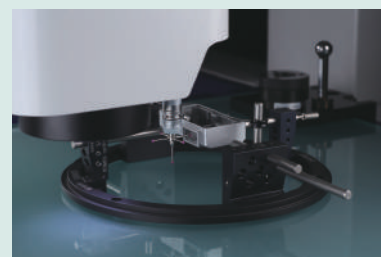

TP20 with opti-fix



MCR20 option

# Quick Vision APEX / HYPER

## Specifications

Illumination (White LED) • Contour • Coaxial • 4 quadrant PRL	Programmable Power Turret (PPT) 1X ; 2X ; 6X
Magnification change system	High sensitivity CCD B&W camera
Sensor Type	For QV APEX and QV HYPER: - TAF Tracking Auto Focus  Refer to the Quick Vision Accessories page for details
Factory option	Refer to the Optical Accessories page for Quick Scope / Quick Vision
Additional objective lenses	Refer to the Optical Accessories page for Quick Scope / Quick Vision

## Optional accessories

No.	Description
<b>Calibration charts</b>	
02ATN695.	Calibration chart with holder

Refer to the Optical Accessories page for Quick Scope / Quick Vision for more information on calibration charts.

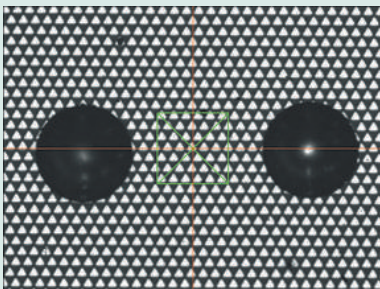

Auto Focus Tool : type Pattern Focus (tool for focusing on difficult surfaces such as mirrors, polished surface clear glass).



Refer to the Quick Vision brochure

This CNC Vision Measuring System is a floor-standing vision measuring machine which offers you the following benefits:

- Programmable LED stage- and coaxial-lighting.
- Programmable 4-quadrant LED ring light.
- Pattern focus function.
- Accuracy specifications conforming to ISO 10360-7 standard (on request).
- Temperature compensation as standard feature.
- Touch probe option.

## Optional PFF Function (Points From Focus)

- PFF enhances the functionality of standard QV models with 3D topography measurements.
- No additional sensor necessary.
- Large scanning range in Z axis from 2,7 mm up to 40,6 mm in wide range mode depending on the objective used.



Workpiece to be measured with PFF

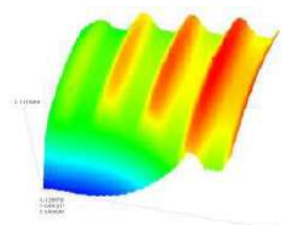

3D Analysis of PFF measurement

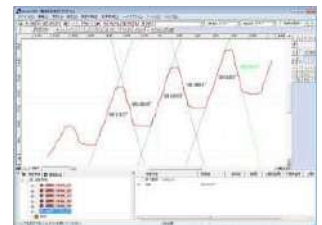

2D Analysis of PFF measurement

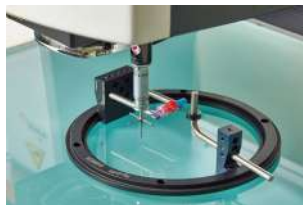

Touch Probe option

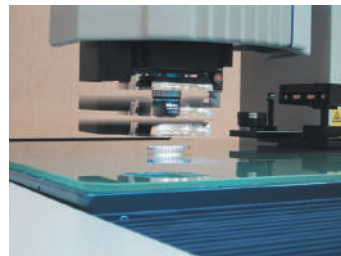

## PRL = Programmable Ring Light

Fine control of angle and direction provides illumination for optimal measurement. You can set the angle in the range from 30° to 80°. This type of illumination is effective for enhancing the edge of inclined surfaces or very small steps. Illumination can be controlled independently from back or front, right or left. Measurement with edge enhancement is possible if you form a shadow by illuminating from only one direction.

# Quick Vision APEX / HYPER

## QV APEX Pro

### QV APEX Pro

CNC Vision Measuring System

All the **QUICK VISION Pro** models are equipped with a strobe light, and the newly developed vision measuring function "StrobeSnap" delivers measurements with both high throughput and high accuracy. Regardless of the continuity of measuring positions, measuring time can be shortened by about 35 to 45% for most measurement samples when compared with our former system.

The **STREAM** function provides an amazingly high throughput, due to the non-stop measurement where the camera motion and the strobe light are synchronized. It can shorten measuring time more than StrobeSnap due to the continuous element measurement as shown in the following conceptual image of measurement.

- This is a superior model of QUICK VISION, which is equipped with the StrobeSnap function as standard, enabling high-speed measurement.
- We offer a model with Tracking Auto Focus (TAF) that quickly focuses on the object improving throughput significantly.
- The camera motion and the strobe light are synchronized to make non-stop vision measurements without stopping the stage. This makes it possible to use STREAM to shorten measuring time dramatically.

### Touch Trigger Probe

CNC Vision Measuring System equipped with optional touch trigger probe.

- Non-contact measurement and contact measurement can be done solely by one unit. QVTP Pro can perform contact measurement by using the vision measuring function and the touch-trigger probe.
- Three-dimensional workpiece measurements can be performed. Enables 3D measurement of workpieces such as press-molded products, plastic-molded products, and cut products, which until now could not be measured with image processing alone.
- Using the probe module change rack allows switching between vision measurement and touch-trigger probe measurement during an automatic measuring sequence.

No.	Model	Measuring range (X×Y×Z)	Max. stage loading
363-601-10	QV Apex 302 Pro - White LED	300 x 200 x 200 mm	20 kg
363-602-10	QV Apex 302 Pro - Colour LED	300 x 200 x 200 mm	20 kg
363-603-10	QV Apex 302 Pro - White LED - TAF	300 x 200 x 200 mm	20 kg
363-604-10	QV Apex 302 Pro - Colour LED - TAF	300 x 200 x 200 mm	20 kg
363-611-10	QV Apex 404 Pro - White LED	400 x 400 x 250 mm	40 kg
363-612-10	QV Apex 404 Pro - Colour LED	400 x 400 x 250 mm	40 kg
363-613-10	QV Apex 404 Pro - White LED - TAF	400 x 400 x 250 mm	40 kg
363-614-10	QV Apex 404 Pro - Colour LED - TAF	400 x 400 x 250 mm	40 kg
363-621-10	QV Apex 606 Pro - White LED	600 x 650 x 250 mm	50 kg
363-622-10	QV Apex 606 Pro - Colour LED	600 x 650 x 250 mm	50 kg
363-623-10	QV Apex 606 Pro - White LED - TAF	600 x 650 x 250 mm	50 kg
363-624-10	QV Apex 606 Pro - Colour LED - TAF	600 x 650 x 250 mm	50 kg



QV Apex 302 Pro



QV Apex 404 Pro



QV Apex 606 Pro



# Quick Vision APEX / HYPER

## QV HYPER Pro

### High-accuracy CNC Vision Measuring System

- The QV HYPER Pro is a highly accurate model that is equipped with a high-resolution/accuracy scale.
- We offer a model with Tracking Auto Focus (TAF) that quickly focuses on the object improving throughput significantly.
- The camera motion and the strobe light are synchronized to make non-stop vision measurements without stopping the stage. This makes it possible to use STREAM to shorten measuring time dramatically.
- There is a general-purpose model with white LED light and an enhanced edge detection model with RGB color LEDs.
- This model is standard-equipped with automatic temperature compensation that uses a temperature sensor on the main unit of the measuring machine and a temperature sensor for the work-piece.

### Touch Trigger Probe

CNC Vision Measuring System equipped with optional touch trigger probe.

- Non-contact measurement and contact measurement can be done solely by one unit. QVTP Pro can perform contact measurement by using the vision measuring function and the touch-trigger probe.
- Three-dimensional workpiece measurements can be performed. Enables 3D measurement of workpieces such as press-molded products, plastic-molded products, and cut products, which until now could not be measured with image processing alone.
- Using the probe module change rack allows switching between vision measurement and touch-trigger probe measurement during an automatic measuring sequence.



QV Hyper 302 Pro



QV Hyper 404 Pro



QV Hyper 606 Pro

No.	Model	Measuring range (X×Y×Z)	Max. stage loading
363-605-10	QV Hyper 302 Pro - White LED	300 x 200 x 200 mm	15 kg
363-606-10	QV Hyper 302 Pro - Colour LED	300 x 200 x 200 mm	15 kg
363-607-10	QV Hyper 302 Pro - White LED - TAF	300 x 200 x 200 mm	15 kg
363-608-10	QV Hyper 302 Pro - Colour LED - TAF	300 x 200 x 200 mm	15 kg
363-615-10	QV Hyper 404 Pro - White LED	400 x 400 x 250 mm	30 kg
363-616-10	QV Hyper 404 Pro - Colour LED	400 x 400 x 250 mm	30 kg
363-617-10	QV Hyper 404 Pro - White LED - TAF	400 x 400 x 250 mm	30 kg
363-618-10	QV Hyper 404 Pro - Colour LED - TAF	400 x 400 x 250 mm	30 kg
363-625-10	QV Hyper 606 Pro - White LED	600 x 650 x 250 mm	40 kg
363-626-10	QV Hyper 606 Pro - Colour LED	600 x 650 x 250 mm	40 kg
363-627-10	QV Hyper 606 Pro - White LED - TAF	600 x 650 x 250 mm	40 kg
363-628-10	QV Hyper 606 Pro - Colour LED - TAF	600 x 650 x 250 mm	40 kg

# Quick Vision ACCEL

## Quick Vision Accel - 3D CNC Vision Measuring System for large work pieces

These CNC camera measuring systems are characterized by a movable bridge structure.

Quick Vision ACCEL instruments offer the following advantages:

- The movable bridge design reduces the need for table movement. This allows for a simpler work-piece clamping design that results in a significant reduction in man-hours required for clamping and inspection of workpieces.
- The system is supplied complete with a stand under the machine.
- 3D topography measurements are possible with the PFF function
- Travel Automatic Focusing (TAF) as a factory supplied option.



No.	Model	Range (X, Y, Z-axis) with Vision Head	Max. drive speed X, Y-axis [mm/s]	Accuracy E1
363-315-20	QV ACCEL 808 PRO	800 x 800 x 150 mm	400	(1,5+3L/1000) μm
363-335-20	QV ACCEL 1010 PRO	1000 x 1000 x 150 mm	400	(1,5+3L/1000) μm

Additional objective lenses

Refer to Objective page for Quick Scope / Quick Vision

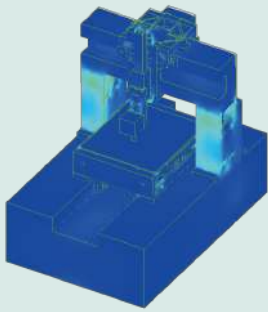

By using FEM (Finite Element Method) analysis of the base design, the placement of stiffening ribs and beams has been determined for the Quick Vision Ultra to provide optimal structural rigidity.



Ultra-precision scale manufacturing facility 11 metres underground

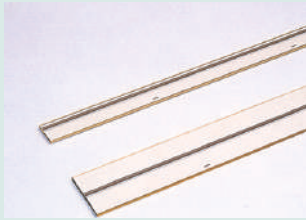

Ultra-high accuracy crystallized glass scale with virtually zero thermal expansion.

The Quick Vision Ultra is equipped with a crystallized glass scale having a resolution of  $0.01 \mu\text{m}$  and linear expansion coefficient of  $0.08 \times 10^{-6}/\text{K}$ . This virtually zero thermal expansion means the Quick Vision Ultra can minimise accuracy fluctuation due to thermal changes.



Quick Vision brochure on request

# Quick Vision ULTRA

## Quick Vision ULTRA

This CNC vision measuring system gives you ultra-high accuracy. The Quick Vision ULTRA offers you the following benefits:

- Axial translation straightness is maximised through the use of a precision air-bearing linear guide system.
- High resolution ( $0,01 \mu\text{m}$ ) scales, manufactured at an ultra-precision facility located 11 m underground, are used on all axes.
- The scales are made from glass that has a virtually zero thermal expansion coefficient, so your measuring accuracy has minimal variation in changing temperatures.
- The base structure was designed using Finite Element Method analysis; this gives you the optimal stiffness/weight ratio combined with excellent geometrical stability, in terms of axial straightness / perpendicularity, with changing temperatures.
- Accuracy specification conforming to ISO 10360-7 are available (on request).
- 3D topography measurements are possible with the optional PFF functionality.



Quick Vision ULTRA 404 PRO

No.	Model	Factory option	Measuring range (X×Y×Z)
363-520-10	QV-U404P1L-E	Refer to Quick Vision Accessories page	400 x 400 x 200 mm
363-521-10	QV-U404T1L-E	- Tracking Auto Focus (TAF) Refer to Quick Vision Accessories page	400 x 400 x 200 mm

# Quick Vision HYBRID Type 4 Series

## Quick Vision HYBRID

- This dual system with a non-contact displacement sensor has a scanning function that enables measurement of minute height differences and 3D shapes.
- The non-contact displacement sensor (CPS probe) uses the wavelength confocal method.
- The LED used as the light source of the displacement sensor has an auto-brightness control function that enables seamless measurement of materials with different reflectivity.



### Hybrid Type 4 system

The Quick Vision Hybrid Type 4 is a machine which allows vision measurement with a CCD camera and high-speed scanning with a non-contact displacement sensor.

The Hybrid Type 4 CPS sensor is available for Quick Vision Apex/Hyper models.

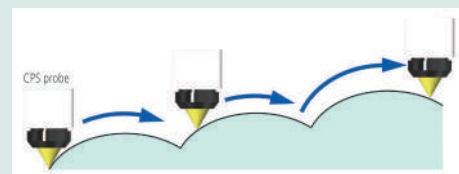

Scanning measurement with automatic movement of the Z-axis

No.	Model	Measuring range (X×Y×Z)	Non-contact displacement sensor measuring range (X×Y×Z) [mm]	Non-contact displacement sensor measuring accuracy [μm]
365-601-10	QVH4A-X302P1L-E	300 x 200 x 200 mm	176 x 200 x 200	E1Z (1,5 + 4L/1000)
365-605-10	QVH4A-H302P1L-E	300 x 200 x 200 mm	176 x 200 x 200	(1,5 + 2L/1000)
365-611-10	QVH4A-X404P1L-E	400 x 400 x 250 mm	276 x 400 x 250	E1Z (1,5 + 4L/1000)
365-615-10	QVH4A-H404P1L-E	400 x 400 x 250 mm	276 x 400 x 250	(1,5 + 2L/1000)
365-621-10	QVH4A-X606P1L-E	600 x 650 x 250 mm	476 x 650 x 250	E1Z (1,5 + 4L/1000)
365-625-10	QVH4A-H606P1L-E	600 x 650 x 250 mm	476 x 650 x 250	(1,5 + 2L/1000)



Form analysis of plastic molded parts having a slope.

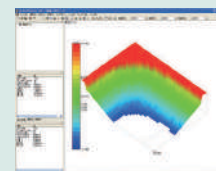

Solid colour display

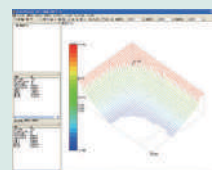

Shaped display

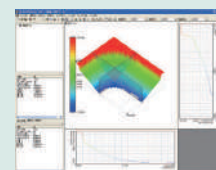

Extraction of arbitrary section



# Quick Vision White Light Interferometer

## Optional accessories

No.	Description
02ALY400	Quick Vision WLI Objective, A-5X
02ALT630	Quick Vision WLI Objective, A-10X
02ALT670	Quick Vision WLI Objective, A-25X
02AWB150	Quick Vision WLI Objective, A-50X



QV WLI Objective lenses

Magnification 5X: Field of View 0,64 x 0,48 mm

Magnification 10X: Field of View 0,32 x 0,24 mm

Magnification 25X: Field of View 0,128 x 0,096 mm

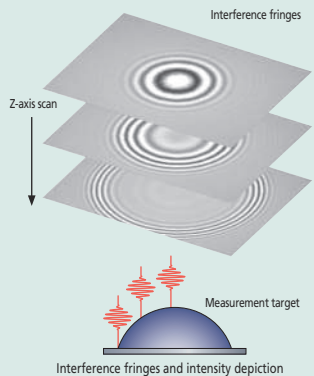
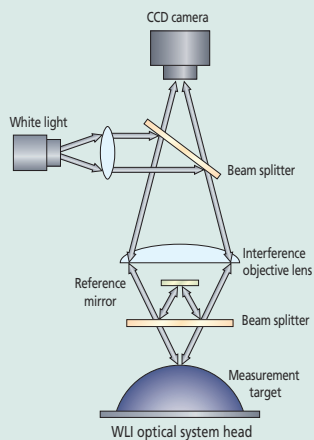

## Quick Vision WLI

- Combines non contact measurements with vision system and White Light Interferometer (WLI).
- Easy alignment and positioning with vision sensor.
- Full QVPAK functionality with vision system.
- Enhanced functionality with WLI-system for high resolution topography evaluation such as surface roughness analysis.



Quick Vision WLI 404 PRO

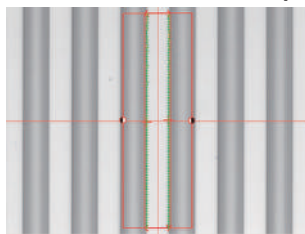

Video image of part

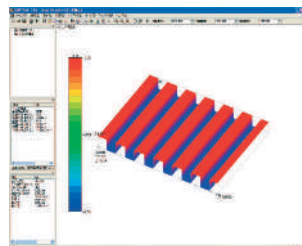

3D Analysis of measured part

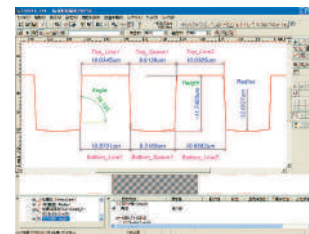

2D Analysis of measured part

## Specifications when using vision sensor are same as Quick Vision HYPER

Model	QVW-H404P1L-D	QVW-H606P1L-D
No.	363-716-10	363-717-10
Model	Hyper Quick Vision WLI 404	Hyper Quick Vision WLI 606
Range (X, Y, Z-axis) with Vision Head	400 x 400 x 240 mm	600 x 650 x 220 mm
Range with WLI Head	315 x 400 x 240 mm	515 x 650 x 220 mm
Repeatability WLI Head	$2\sigma \leq 0,08\mu\text{m}$	$2\sigma \leq 0,08\mu\text{m}$
Tube Lens WLI Head	2x	2x
Z-axis measuring range WLI Head	170 $\mu\text{m}$	170 $\mu\text{m}$
Max. stage loading	25 kg	35 kg



Scan QR Code with your mobile device and watch our product videos on YouTube

# 3D CNC Multisensor Measuring Machines MiSCAN

## MiSCAN

The MiSCAN MVS-HYPER and MVS-APEX vision systems combine advanced image processing with tactile scanning measurements.

- The MVS-HYPER 302 can be equipped with either the MPP-Nano probe or SP25M scanning probe.
- MPP-Nano is a high accuracy scanning probe for measurement of minute parts and uses stylus modules with tip diameters varying from 125 up to 500  $\mu\text{m}$ .
- MVS-HYPER 404 and MVS APEX 404 models are equipped with the SP25M scanning probe for standard scanning jobs with medium size measuring range.
- The MiSCAN Vision Systems are driven by the powerful combination of MCOSMOS and VISION-PAK-PRO software to guarantee maximum functionality for both non-contact and tactile measurements.
- All the benefits of the standard QUICK VISION HYPER/APEX systems are also incorporated in the MiSCAN Vision systems.

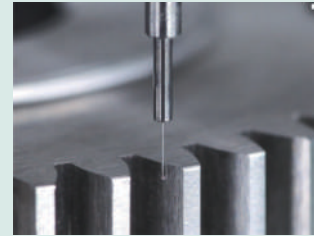

MPP-NANO Module 0.8 master gear measurement

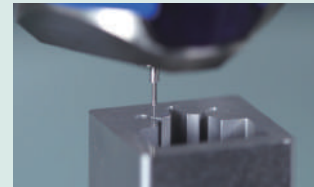

MPP-NANO mold scanning



SP25M

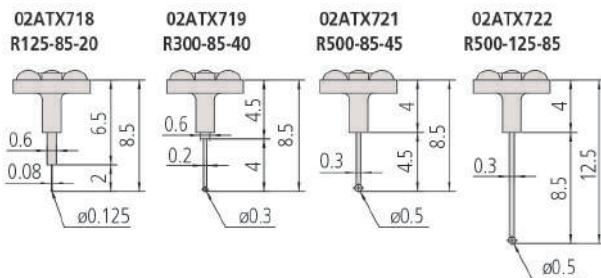
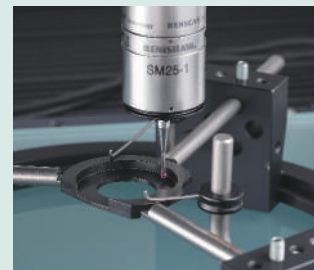

MPP-Nano touch probes



Type	MiSCAN HYPER 302	MiSCAN APEX 404	MiSCAN HYPER 404
No.	364-502-10S	364-511-10S	364-512-10S
Model	MVS-H302P1L-D	MVS-X404P1L-D	MVS-H404P1L-D
Resolution $\mu\text{m}$	0,02	0,1	0,02
Measuring range using vision sensor	300 x 200 x 200 mm	400 x 400 x 250 mm	400 x 400 x 250 mm
Measuring range using scanning probe	175 x 200 x 200 mm	275 x 400 x 250 mm	275 x 400 x 250 mm
Measurement accuracy with vision sensor [ $\mu\text{m}$ ]	$E_{1x}, E_{1y} = (0,8+2L/1000)$ $E_{1z} = (1,5+2L/1000)$ $E_{2xy} = (1,4+3L/1000)$	$E_{1x}, E_{1y} = (1,5+3L/1000)$ $E_{1z} = (1,5+4L/1000)$ $E_{2xy} = (2,0+4L/1000)$	$E_{1x}, E_{1y} = (0,8+2L/1000)$ $E_{1z} = (1,5+2L/1000)$ $E_{2xy} = (1,4+3L/1000)$
Measurement accuracy with scanning probe [ $\mu\text{m}$ ]	$E_{0,MPE} = (1,9+4L/1000)$	$E_{0,MPE} = (2,5+6L/1000)$	$E_{0,MPE} = (1,9+4L/1000)$
Mass kg	360	579	579
Max. stage loading	15 kg	40 kg	30 kg

# UMAP Vision System Series

## UMAP: Ultrasonic Micro and Accurate Probe

The UMAP (Ultrasonic Micro and Accurate Probe) is a micro-form measuring system

The UMAP offers you the following benefits:

- Dual functions of high-accuracy contact and non-contact measurement in one machine.
- Contact (micro-stylus UMAP probe) and non-contact (vision probe) measuring probes are installed.
- You can measure micro-features of parts previously impossible to reach.
- Several diameters of micro-stylus are available from 15  $\mu\text{m}$  to 300  $\mu\text{m}$ .



UMAP Probe Unit



UMAP Hyper 302



UMAP Ultra 404

**UMAP Probes**  
(ultrasonic micro stylus probes)  
Stylus ultrasonic micro-vibration and its amplitude-sensing enable UMAP probe to perform contact measurement of micro-features of parts.  
5 choices of stylus tip diameter are available from 15  $\mu\text{m}$  to 300  $\mu\text{m}$ .



UMAP 101  
 $\phi 15 \mu\text{m}$   
L = 0,2 mm



UMAP 103  
 $\phi 30 \mu\text{m}$   
L = 2 mm



UMAP 107  
 $\phi 70 \mu\text{m}$   
L = 5 mm



UMAP 110  
 $\phi 100 \mu\text{m}$   
L = 10 mm



UMAP 130  
 $\phi 300 \mu\text{m}$   
L = 16 mm

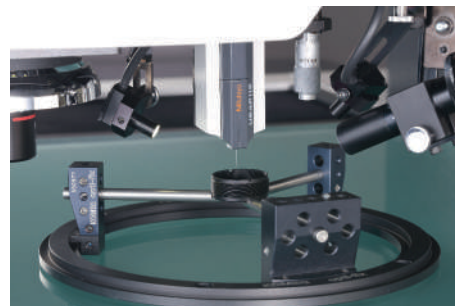

UMAP System

Type	UMAP HYPER 302	UMAP ULTRA 404
No.	364-714-10	364-718-10
Measuring range using vision sensor	300 x 200 x 200 mm	400 x 400 x 200 mm
Measuring range using scanning probe	185 x 200 x 175 mm	285 x 400 x 175 mm
Measurement accuracy with vision sensor [ $\mu\text{m}$ ]	$E_{UX,MPE} / E_{UY,MPE} = (0,8+2L/1000)$ $E_{UZ,MPE} = (1,5+2L/1000)$ $E_{UXY,MPE} = (1,4+3L/1000)$	$E_{UX,MPE} / E_{UY,MPE} = (0,35+1,3L/1000)$ $E_{UZ,MPE} = (1,5+2L/1000)$ $E_{UXY,MPE} = (0,5+2L/1000)$
Measurement accuracy with scanning probe [ $\mu\text{m}$ ]	$E_{0,MPE} = (2,2+4L/1000)$	$E_{0,MPE} = (2,0+4L/1000)$
Resolution [ $\mu\text{m}$ ]	0,02	0,01
Max. stage loading	15 kg	40 kg
Mass	280 kg	2160 kg



Refer to the UMAP Vision system brochure



# Software for Quick Vision Machines

## QVPAK

- QVPAK controls multiple sensors: Vision sensor, Touch Probe, continuous scanning devices, special UMAP or LNP probes.
- Powerful mathematical algorithms are provided that help you to detect difficult edges via noise filters (similar to morphological filters) and advanced detection tools that take into account the texture of the target surface.
- Partprogramming and editing is made easy with the user friendly Easy Editor.
- 3D graphic display or measuring planes display with the QVclient QVGraphic.
- QVPAK also offers you various QVclients (standard), assistants for users (programming mode) or operators (production mode) such as QVSmartEditor and QVNavigator.

## Optional software modules for Quick Vision System

- Formtracepak-AP-QV for 2D contour analysis.
- Formtracepak-Pro for 3D surface analysis.
- QV Part Manager for managing the execution of parts programs of multiple parts.
- Easypag-Pro for offline generation of part programs from 2D CAD data.
- QV3DCAD for online generation of part programs from 3D CAD files.
- MeasurLink for statistical process control (SPC).
- QV3DPAK for 3D topography measurements (see explanation below).
- For more information refer to the Vision Measuring Machines brochures.

## Optional PFF Function (Points From Focus)

- PFF enhances the functionality of standard QV models with 3D topography measurements.
- No additional sensor necessary.
- High scanning range in Z axis from 2,7 mm upto 40,6 mm depending on the objective lens in use and in wide range mode.
- PFF is a retro fittable option for Quick Vision APEX/HYPER and Quick Vision ULTRA. Please contact your local Mitutoyo office for more detailed information.



Workpiece to be measured with PFF

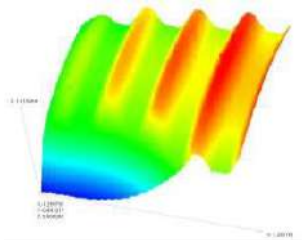

3D Analysis of PFF measurement

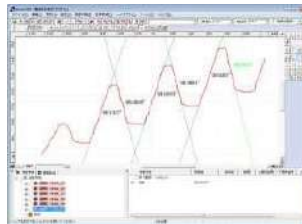

2D Analysis of PFF measurement

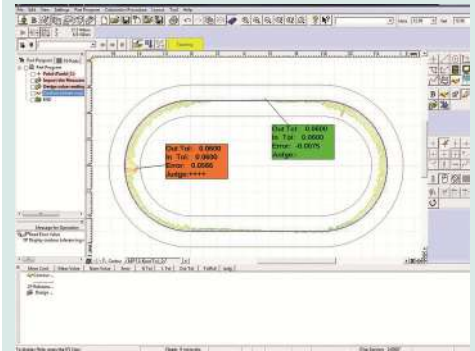

FORMPAK-AP

- Simple and easy-to-use 2D contour analysis.
- Graphic reports (geometry or scanning) edition.
- Allows measurement by comparison. For more information refer to FORMTRACEPAK-AP.

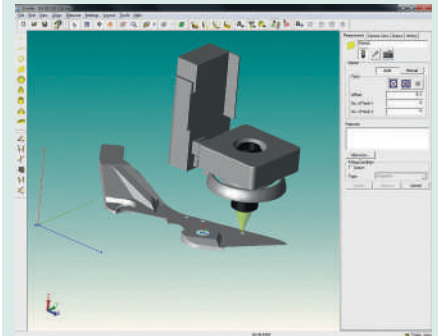

QV 3D CAD-Online

- Automatic program generation from 3D CAD files issued from a CAD system (must be associated with a converter).



Vision Measuring Machines brochures on request

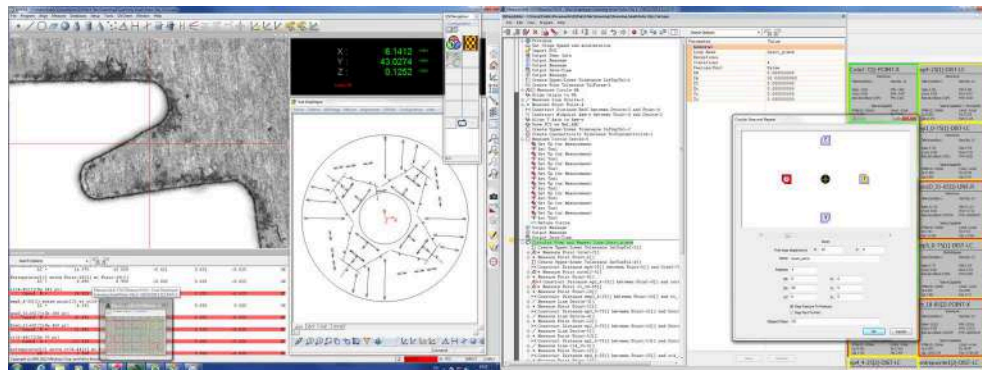

Example of the QVPAK screen layout.



# Accessories for Quick Vision Machines

## Touch Probe Option

An optional touch probe (TP) is available for following QV models:  
Quick Vision ACTIVE; Quick Vision APEX ; Quick Vision HYPER ; Quick Vision ACCEL.

- The Quick Vision-TP system allows you to carry out both non-contact and contact measurements.
- Compatible with Renishaw Touch Probe TP 20 or TP 200.
- An optional MCR20 rack for storing probe modules enhances functionality even more.



Styli kit M2  
Starter

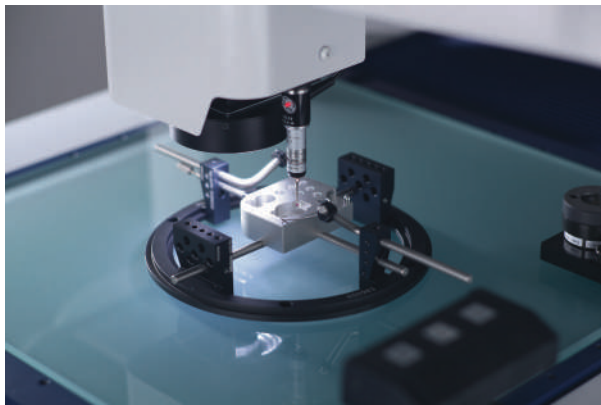

Quick Vision ACTIVE with Touch Probe option



Master ball/ring



Refer to the Quick Vision brochure



CNC Vision Measuring System Equipped with a Touch-Trigger Probe



TP20  
Compact stylus change type



TP200  
Compact and high accuracy stylus change type

# Objective Lenses and Calibration Charts

## Quick Vision WLI Objective

No.	Model	Magnification 1*	Total magnification *2	Focal length [mm]	Working distance [mm]	Depth of focus [μm]	Field of View *2 [mm]
02ALY400	QV WLI A-5X	5x	10x	20	13,2	3,5	0,64 x 0,48
02ALT630	QV WLI A-10X	10x	20x	10	12,6	3,5	0,32 x 0,24
02ALT670	QV WLI A-25X	25x	50x	4	4,7	1,1	0,13 x 0,1
02AWB150	QV WLI A-50X	50x	100x	2	2,4	0,6	0,064 x 0,048

\*1: Value when the focal length of the tube lens (1x) is 100 mm

\*2: Value when the product is mounted to the WLI optical head (when the 2x tube lens and 1/2-inch CCD camera are used)

## Objective Lenses and Calibration Charts

### 1. QV-Objective lens - HR (High Resolution) and SL (Long Working Distance) models

No.	Magnification	Model	Turret lens Mag. QV	Monitor Mag. QV	Working distance [mm]
02AKT199	0,5X	QV-SL0,5X	1X 2X 6X	16X 32X 96X	30,5
02ALA150	1X	QV-SL1X	1X 2X 6X	32X 64X 192X	52,5
02ALA170	2,5X	QV-SL2,5X	1X 2X 6X	80X 160X 480X	60
02ALA420	5X	QV-5X	1X 2X 6X	160x 320X 960X	33,5
02ALG010	10X	QV-SL10X	1X 2X 6X	320X 640X 1920X	30,5
02ALG020	25X	QV-25X	1X 2X 6X	800X 1600X 4800X	13
02AKT250	1X	QV-HR1X	1X 2X 6X	32X 64X 192X	40,6
02AKT300	2,5X	QV-HR2,5X	1X 2X 6X	80X 160X 480X	40,6
02AKT650	10X	QV-HR10X	1X 2X 6X	320X 640X 1920X	20

### Remarks

- The monitor magnifications are approximate values.
- QV-10X, QV-25X: Depending on the workpiece the illumination may be insufficient at a turret lens magnification of 2X and 6X for QV models.
- QV-25X: The PRL illumination is restricted in its usable position.



Calibration glass chart & Compensation glass chart with holder

A calibration or compensation chart is used to calibrate or compensate for the pixel size of the CCD and CMOS sensors, autofocus accuracy and the optical axis offset at each magnification of the Programmable Power Turret (PPT) or of the zoom.

## QV Index

### Rotary Head

Using the QV Index to rotate the workpiece makes it possible to automatically measure multiple surfaces without having to dismount/remount the workpiece.

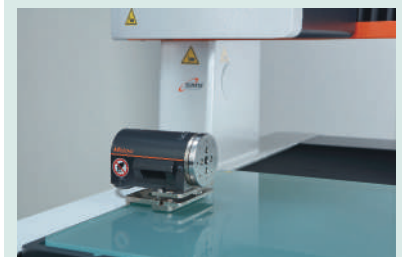

optional on special request

# Modular Clamping System opti-fix

opti-fix Clamping System

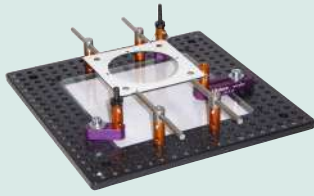

Transmitted light plate



opti-fix frame & mini-vise



opti-fix set-up for rotationally symmetric parts



Discover the Mitutoyo online fixture system catalogue or download the PDF



Mitutoyo fixtures:  
For measurably better results.

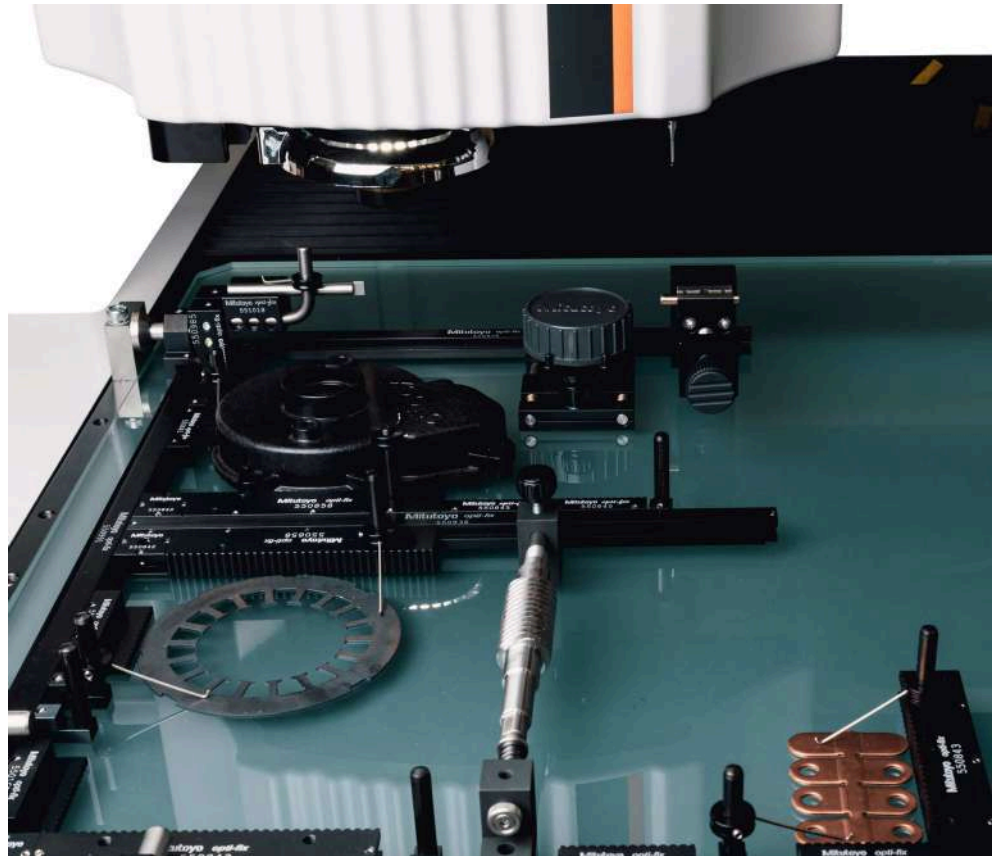

Magnetic clamps fixing the opti-fix frame to the machine table to secure repeatable positioning

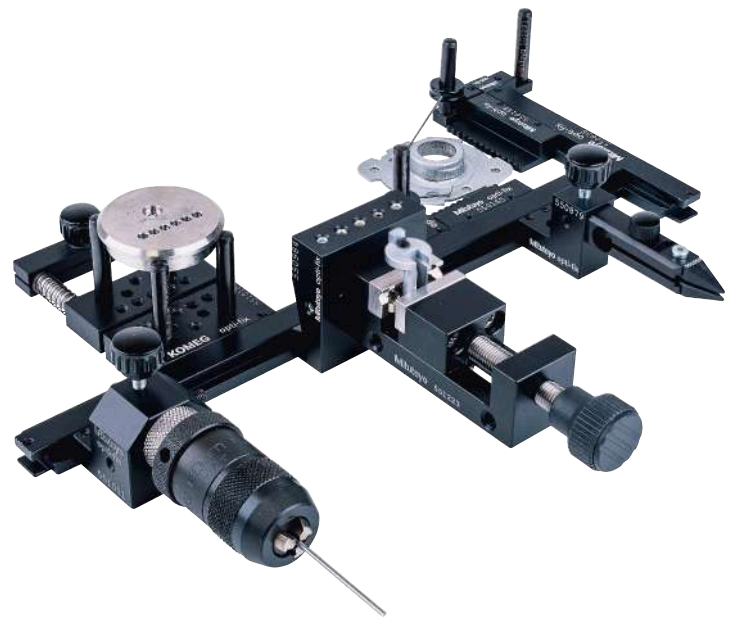

Different options for part clamping by vise, chuck tweezers or springs