

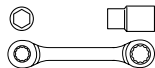

HÖGERT
technik

DE Mechanische Werkzeuge
EN Mechanical Tools
FR Outils Mécaniques
ES Herramientas Mecánicas
HR Mehanički Alati
HU Mechanikus Szerszámok
RO Unelte Mecanice
BG Механични Инструменти

DE Doppelring Ratschen Steckschlüssel mit Ersatzteilen EN Double ratchet wrench with sockets FR Clé à cliquet double réversibles avec jeux de douilles ES Llave de tubo de trinquete de doble cabezal HR Okasti ključ s čegrtaljkom s nastavcima HU Racsnis kulcskészlet RO Set chei cu clichet BG Ключ звездогаечен с тресчотка



8, 9, 10, 11, 12, 13, 15, 16, 17, 18 mm

14, 19 mm



×11 72T CrV

HT1R490	14 x 19 mm	5	20

DE Werkzeugsatz EN Tool set FR Kit d'outils ES Set de herramientas HR Garnitura alata HU Szerszámkészlet RO Trusa de scule BG Комплект инструменти

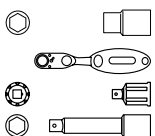

1/4":

10, 11, 12, 13, 14, 15, 16, 17, 18, 19, 21, 22, 24 mm

19 mm

1/4", 3/8"

80, 150 mm



mm	10	11	12	13	14	15	16	18	19	21	22	24
inch	3/8	7/16	15/32	1/2		19/32	5/8		3/4	13/16	7/8	15/16
star	E12	E14	E16		E18		E20	E22	E24			

×18 19 mm SPLINE GO-THROUGH 60T CrV CrMo ERGO TRAY

HT1R478	19 mm	1	8

DE Doppelring Ratschen Steckschlüssel mit Ersatzteilen EN Double ratchet wrench with sockets FR Clé à cliquet double réversibles avec jeux de douilles ES Llave de tubo de trinquete de doble cabezal HR Okasti ključ s čegrtaljkom s nastavcima HU Racsnis kulcskészlet RO Set chei cu clichet BG Ключ звездогаечен с тресчотка и вложки

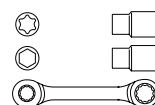

8, 9, 10, 11, 12, 13, 15, 16, 17, 18 mm

E8, E10, E11, E12, E14, E16, E18, E20, E22 mm

14, 19 mm



×20 72T CrV

HT1R492	14 x 19 mm	5	20

DE Werkzeugsatz EN Tool set FR Kit d'outils ES Set de herramientas HR Garnitura alata HU Szerszámkészlet RO Trusa de scule BG Комплект инструменти



x53 1/4" AS SYSTEM 72 T CrV CrMo ERGO TRAY

- 1/4":**
- 4, 4.5, 5, 5.5, 6, 7, 8, 9, 10, 11, 12, 13 mm
 - 1/4"
 - 72T
 - 150 mm
 - 100 mm
 - Universal joint
 - PH1, 2 x PH2, PH3
 - PZ1, PZ2, PZ3
 - SL3, SL4, SL5, SL5.5 mm
 - H3, H4, H5, H6, H8
 - M5, M6, M8
 - TT8, TT10, TT15, TT20, TT25, TT27, TT30, TT40
 - 1, 2, 3
 - 6, 8, 10
 - 1.5, 2.0, 2.5 mm



HT1R485	1/4"	1	10

DE Werkzeugsatz EN Tool set FR Kit d'outils ES Set de herramientas HR Garnitura alata HU Szerszámkészlet RO Trusa de scule BG Комплект инструменти



x29 1/2" AS SYSTEM 6 PT 72 T CrMo ERGO TRAY

- 1/2":**
- 8, 9, 10, 11, 12, 13, 14, 15, 16, 17, 18, 19, 20, 22, 24, 27, 30, 32, 36 mm
 - 15, 17, 19 mm
 - 16, 21 mm
 - 125, 250 mm
 - Uniwersal joint
 - 3 way Adapter
 - 1/2"



HT1R480	1/2"	1	4

DE Werkzeugsatz EN Tool set FR Kit d'outils ES Set de herramientas HR Garnitura alata HU Szerszámkészlet RO Trusa de scule BG Комплект инструменти



x34 1/4" AS SYSTEM 6 PT 72 T CrV S2 ERGO TRAY

- 1/4":**
- 4, 4.5, 5, 5.5, 6, 7, 8, 9, 10, 11, 12, 13 mm
 - SL4, SL5,5, SL7 mm
 - PH1, PH2, PH3, PZ1, PZ2, PZ3
 - T15, T20, T25
 - H3, H4, H5, H6, H7, H8 mm;
 - 150 mm
 - 72T
 - 75 mm
 - Uniwersal joint



HT1R464	1/4"	1	8

DE Doppel Ratschenringschlüssel mit Gelenk mit Ersatzteilen EN Flexible double ratchet wrench with sockets FR Clés à douille et cliquets double réversibles avec jeux de douilles ES Llave combinada de trinquete flexible HR Okasti ključ s čegrtaljkom i zglobom s nastavcima HU Csuklós fejű kombinált racsnis kulcs RO Cheie combinata cu clichet, articulata BG Ключ звездогаечен с тресчотка с подвижна глава и вложки



- ⊖ SL3, SL5, SL7 mm
- ⊕ PH1, PH2, PH3
- ⊕ PZ1, PZ2, PZ3
- H2, H3, H4, H5, H6 mm
- ⊗ T15, T20, T25, T30, T40
- ▲ 2, 3
- ⊖ 4, 6, 8

- 1/4"
- 8, 9, 10, 11, 12, 13, 15, 16, 17, 18 mm
- 14, 19 mm



x36 FLEXIBLE HEAD 72T CrV

HT1R491	14 x 19 mm	5	20

DE Werkzeugsatz EN Tool set FR Kit d'outils ES Set de herramientas HR Garnitura alata HU Szerszámkészlet RO Trusa de scule BG Комплект инструменти



- 3/8":**
- 6, 7, 8, 9, 10, 11, 12, 13, 14, 15, 16, 17, 18, 19, 20, 21, 22, 24 mm
 - 8, 9, 10, 11, 12, 13, 14, 15, 16, 17, 18, 19 mm
 - 72T
 - 43, 100, 200 mm
 - Universal joint
 - Sliding adapter



x36 3/8" AS SYSTEM 6 PT 72T CrV S2 CrMo ERGO TRAY

HT1R465	3/8"	1	4

DE Werkzeugsatz EN Tool set FR Kit d'outils ES Set de herramientas HR Garnitura alata HU Szerszámkészlet RO Trusa de scule BG Комплект инструменти



- Bits 10 mm**
- length 30 mm:**
- ⊕ PH2, PH3
 - ⊗ T20, T25, T30, T40, T45, T50, T55, T60
 - M5, M6, M8, M10, M12
 - H4, H5, H6, H8, H10, H12 mm
- length 75 mm:**
- ⊗ T25, T27, T30, T40, T45, T50, T55
 - H5, H6, H7, H8, H10 mm
- length 120 mm:**
- ⊗ T45, T50, T55
- 10 mm bits



x37 72T CrMo S2 PH SPLINE TORX HEX

HT1R466	10 mm	1	8

DE Werkzeugsatz EN Tool set FR Kit d'outils ES Set de herramientas HR Garnitura alata HU Szerszámkészlet RO Trusa de scule BG Комплект инструменти



- 1/4":**
- ⊙ 5, 5, 6, 7, 8, 9, 10, 11, 12, 13, 14 mm
 - ⊖ SL3, SL4, SL5, SL6 mm
 - ⊕ PH1, PH2 x 2, PH3
 - ⊕ PZ1, PZ2, PZ3
 - ⊕ TT10, TT15, TT20, TT25, TT27, TT30, TT40
 - ⊕ H3, H4, H5, H6 mm
 - 150 mm
 - 72T
 - ⊕ 50, 100 mm
 - ⊕ Universal joint
 - ⊕ 1/4"



x38	1/4"	AS SYSTEM	72 T	CrMo	S2	CrV	ERGO TRAY
-----	------	-----------	------	------	----	-----	-----------

HT1R462	1/4"	5	20



DE Werkzeugsatz **EN** Tool set **FR** Kit d'outils **ES** Set de herramientas **HR** Garnitura alata
 HU Szerszámkészlet **RO** Trusa de scule **BG** Комплект инструменти

DE Werkzeugsatz **EN** Tool set **FR** Kit d'outils **ES** Set de herramientas **HR** Garnitura alata
 HU Szerszámkészlet **RO** Trusa de scule **BG** Комплект инструменти



1/4":

- SL4, SL5,5, SL7
- ⊕ PH1, PH2, PH3
- ⊕ PZ1, PZ2, PZ3
- ⊗ T10, T15, T20, T25, T27, T30, T40
- H3, H4, H5, H6, H7, H8
- ⊙ 4, 4.5, 5, 5.5, 6, 7, 8, 9, 10, 11, 12, 13, 14 mm
- 72T
- ⊙ 50/100 mm
- 150 mm
- 30 mm
- 150 mm
- 1/4"
- ⊙ Universal joint
- 1.27, 1.5, 2, 2.5 mm

1/2":

- ⊙ 8, 10, 11, 12, 13, 14, 15, 16, 17, 18, 19, 21, 22, 24, 27, 30, 32 mm
- ⊙ Universal joint
- ⊙ 3 way Adapter
- ⊙ 75, 254 mm
- 72T
- ⊙ 16/21 mm



x47	1/4"	AS SYSTEM
72 T	CrMo	CrV

HT1R416	1/4"	1	10

x24	1/2"	AS SYSTEM
72 T	CrMo	CrV

HT1R410	1/2"	1	4

DE Werkzeugsatz EN Tool set FR Kit d'outils ES Set de herramientas HR Garnitura alata HU Szerszámkészlet RO Trusa de scule BG Комплект инструменти



1/4":

- 5, 5.5, 6, 7, 8, 9, 10, 11, 12, 13 mm
- Universal joint
- 75 mm
- 1/4"
- 150 mm
- 110 mm
- 1/4"
- 1/4"
- PH1, PH2, PH3
- SL4.5 SL6.5 SL8
- H3, H4, H5, H6
- T10, T15, T20, T25, T27, T30, T40

1/2":

- 8, 9, 10, 11, 12, 13, 14, 15, 16, 17, 18, 19, 21, 22, 24, 27, 30, 32 mm
- 16, 21 mm
- Universal joint
- 125, 250 mm
- 1/2", 250 mm
- 72T

mm	5,5	6	8	10	11	12	13	14	15	16	18	19	21	22	24	27	30	32
inch	7/32	5/16	3/8	7/16	15/32	1/2		19/32	5/8		3/4	13/16	7/8	15/16	1,1/16	1,1/8	1,1/4	
star	E8	E10	E12	E14	E16	E18		E20	E22	E24								



x60	SPLINE	1/4" 1/2"	72 T
CrV	S2	ERGO TRAY	

HT1R470	1/4", 1/2"	1	3

DE Werkzeugsatz EN Tool set FR Kit d'outils ES Set de herramientas HR Garnitura alata HU Szerszámkészlet RO Trusa de scule BG Комплект инструменти



1/4":

- 4, 4.5, 5, 5.5, 6, 7, 8, 9, 10, 11, 12, 13, 14 mm
- 4, 4.5, 5, 5.5, 6, 7, 8, 9, 10, 11, 12, 13, 14 mm
- E4, E5, E6, E7, E8, E10
- 50, 100, 150 mm
- 140 mm
- 110 mm
- Universal joint
- 150 mm
- 72T
- 1/4"
- SL4, SL5.5, SL7
- PZ1, PZ2, PZ3
- PH1, PH2, PH3
- T8, T10, T15, T20, T25, T30, T40
- H3, H4, H5, H6, H7, H8

x63	1/4"	AS SYSTEM
72 T	CrMo	CrV



HT1R486	1/4"	1	4

DE Werkzeugsatz EN Tool set FR Kit d'outils ES Set de herramientas HR Garnitura alata HU Szerszámkészlet RO Trusa de scule BG Комплект инструменти

DE Werkzeugsatz EN Tool set FR Kit d'outils ES Set de herramientas HR Garnitura alata HU Szerszámkészlet RO Trusa de scule BG Комплект инструменти



1/4":

- 4, 4.5, 5, 5.5, 6, 7, 8, 9, 10, 11, 12, 13, 14 mm
- 50, 100 mm
- 150 mm
- Universal Joint
- 152 mm
- 1/4" bits
- 72T
- 150 mm
- SL 4, SL 5.5, SL 7
- PH1, PH2
- PZ1, PZ2
- T8, T10, T15, T20, T25, T30
- H3, H4, H5, H6

5/16":

- SL 8, SL 10, SL 12
- PH3, PH4
- PZ3, PZ4
- T40, T45, T50, T55
- H8, H10, H12, H14

1/2":

- 14, 15, 16, 17, 18, 19, 20, 22, 24, 27, 30, 32 mm
- 125, 250 mm
- 3 way adapter
- Universal Joint
- 16, 21 mm
- 5/16"
- 72T
- 8, 10, 11, 12, 13, 14, 17, 19, 22 mm
- 1.5, 2.0, 2.5 mm

1/4":

- 4, 4.5, 5, 5.5, 6, 7, 8, 9, 10, 11, 12, 13, 14 mm
- 150 mm
- 115 mm
- 50, 100 mm
- 72T
- SL4, SL5, SL5.5, SL6, SL8 mm
- PH1, PH2
- PZ1, PZ2
- T8, T10, T15, T20x2, T25x2, T27, T30
- TT8, TT10, TT15, TT20, TT25, TT27, TT30
- H3, H4, H5, H6
- TH3, TH4, TH5, TH6
- 1, 2, 3
- 6, 8, 10
- M5, M6, M8
- 1, 2
- 1/4"

1/2":

- 10, 11, 12, 13, 14, 15, 16, 17, 18, 19, 20, 21, 22, 24, 27, 30, 32, 36 mm
- 3 way adapter
- 254 mm
- 72T
- 1.27, 1.5, 2.0, 2.5, 3.0 mm

x85 1/4" 1/2" AS SYSTEM 72T CrMo CrV

HT1R425 1/4", 1/2" 1 4

x89 1/4" 1/2" AS SYSTEM 72T CrMo CrV

HT1R424 1/4", 1/2" 1 4

DE Werkzeugsatz EN Tool set FR Kit d'outils ES Set de herramientas HR Garnitura alata HU Szerszámkészlet RO Trusa de scule BG Комплект инструменти



- 1/4":**
- ➔ 4, 5.5, 7 mm
 - ➕ PH1, PH2
 - ➕ PZ1, PZ2
 - ⊕ T8, T10, T15, T20, T25, T30
 - H3, H4, H5, H6
 - 4, 4.5, 5, 5.5, 6, 7, 8, 9, 10, 11, 12, 13, 14 mm
 - 6, 7, 8, 9, 10, 11, 12, 13 mm
 - 72T
 - 50, 100 mm
 - 150 mm
 - 30 mm
 - 150 mm
 - 115 mm
 - Universal joint

- 5/16":**
- ➔ 8, 10, 12
 - ➕ PH3, PH4
 - ➕ PPZ3, PZ4
 - ⊕ T40, T45, T50, T55
 - H8, H10, H12, H14

- 1/2":**
- 10, 11, 12, 13, 14, 15, 16, 17, 18, 19, 20, 21, 22, 24, 27, 30, 32 mm
 - 14, 15, 17, 19 mm
 - 72T
 - 125, 250 mm
 - 16, 21 mm
 - 3 Way Adapter
 - 5/16"
 - Universal Joint

1.5, 2, 2.5, 3 mm

x95 AS SYSTEM CrMo CrV

HT1R426	1/2", 5/16", 1/4"	1	4



DE Werkzeugsatz EN Tool set FR Kit d'outils ES Set de herramientas HR Garnitura alata HU Szerszámkészlet RO Trusa de scule BG Комплект инструменти



- 1/4":**
- ➔ 4, 5.5, 7
 - ➕ PH1, PH2
 - ➕ PZ1, PZ2
 - ⊕ TT8, T10, T15, T20, T25, T27, T30
 - H3, H4, H5, H6
 - 4, 4.5, 5, 5.5, 6, 7, 8, 9, 10, 11, 12, 13, 14 mm
 - 6, 7, 8, 9, 10, 11, 12, 13 mm
 - E10, E11, E12, E14, E16, E18, E20, E24
 - 72T
 - 50, 100 mm
 - 150 mm
 - H30 mm
 - 150 mm
 - 115 mm
 - Universal joint

- 1/2":**
- ➔ 8, 10, 12
 - ➕ PH3, PH4
 - ➕ PZ3, PZ4
 - ⊕ T40, T45, T50, T55, T60
 - H7, H8, H10, H12, H14
 - 10, 11, 12, 13, 14, 15, 16, 17, 18, 19, 20, 21, 22, 23, 24, 27, 30, 32 mm
 - 14, 15, 17, 19, 22 mm
 - E10, E11, E12, E14, E16, E18, E20, E24
 - 72T
 - 125, 250 mm
 - 16, 21 mm
 - 3 way adapter
 - Universal Joint

1.27, 1.5, 2, 2.5 mm

x112 AS SYSTEM CrMo CrV

HT1R432	1/4", 1/2"	1	4



DE Werkzeugsatz EN Tool set FR Kit d'outils ES Set de herramientas HR Garnitura alata HU Szerszámkészlet RO Trusa de scule BG Комплект инструменти



- 1/4":**
- 4, 4.5, 5, 5.5, 6, 7, 8, 9, 10, 11, 12, 13, 14 mm
 - 6, 7, 8, 9, 10, 11, 12, 13 mm
 - E4, E5, E6, E7, E8
 - 1/4" x 1/4"
 - 1/4" 75 mm
 - 150 mm
 - 1/4", 115 mm
 - 150 mm
 - 150 mm
 - Universal Joint: SL3; SL4, SL4.5; SL5; SL5.5; SL6; SL7
 - PH0, PH1, PH2, PH3, PH4
 - PZ0, PZ1, PZ2, PZ3, PZ4
 - H1.5; H2; H2.5; H3, H4, H5, H6
 - T10; T15, T20; T25; T27; T30
 - 72T

- 3/8":**
- 13, 14, 15, 16, 17, 18, 19 mm
 - 13, 14, 15 mm
 - E10, E11, E12, E14, E16, E18
 - 3/8 F x 1/4 M
 - 150 mm
 - Universal Joint
 - 72T
- 1/2":**
- 20, 21, 22, 24, 27, 30, 32 mm
 - 15, 17, 19 mm
 - E20, E22, E24
 - 16, 21 mm
 - 127, 254 mm
 - 3 way Adapter
 - Universal Joint
 - 72T

- 180 mm
- 160 mm
- 300 g
- Combination spanner: 8, 9, 10, 11, 12, 13, 14, 15, 16, 17, 18, 19 mm
- HEX keys: 1.5, 2, 2.5, 3, 4, 5, 6, 8, 10 mm
- Adjustable wrench: 250 mm
- Voltage tester: 110-250V
- Screwdrivers 2 pcs.: PH2 x 100 mm, SL6 x 100 mm
- Cutter: 175 mm
- Utility knife: 18 mm
- Magnetic holder

x131
1/4" 3/8" 1/2"
AS SYSTEM
72T
CrMo
CrV

HT1R439	10 mm	1	8

DE Werkzeugsatz EN Tool set FR Kit d'outils ES Set de herramientas HR Garnitura alata HU Szerszámkészlet RO Trusa de scule BG Комплект инструменти



- 1/4":**
- 4, 4.5, 5, 5.5, 6, 7, 8, 9, 10, 11, 12, 13, 14 mm
 - 6, 7, 8, 9, 10, 11, 12, 13 mm
 - SL4, SL5.5, SL7
 - PH1, PH2
 - PZ1, PZ2
 - T8, T10, T15, T20, T25, T30
 - H3, H4, H5, H6
 - 150 mm
 - 115 mm
 - 50, 100 mm
 - Universal Joint
 - 150 mm
 - Bit holder
 - 72T
 - Hex key: 1.27x2, 1.5x2, 2.0x2, 2.5, 3.0 mm

- SL4, SL5, SL5.5, SL6, SL8
- PH1, PH2
- PZ1, PZ2
- T8, T10, T15, T20x2, T25x2, T27, T30
- TT8, TT10, TT15, TT20, TT25, TT27, TT30
- H3, H4, H5, H6
- TH3, TH4, TH5, TH6
- TRI-WING: 1, 2, 3
- TORQ: 6, 8, 10
- SPLINE: M5, M6, M8
- SQUARE: 1, 2
- Bit adapter: 1/4"

- 5/16":**
- 1/2" x 5/16"
 - SL8, SL10, SL12
 - PH3, PH4

- PZ3, PZ4
- T40, T45, T50, T55
- H8, H10, H12, H14

- 1/2":**
- 10, 11, 12, 13, 14, 15, 16, 17, 18, 19, 20, 21, 22, 24, 27, 30, 32, 36 mm
 - 14, 15, 17, 19 mm
 - 16/ 21 mm
 - Universal Joint
 - 3 way Adapter
 - 125, 245 mm
 - 72T

x144	1/4" 1/2"	AS SYSTEM	72T	CrMo	CrV
------	--------------	--------------	-----	------	-----

HT1R440	1/4", 1/2"	1	3

DE Werkzeugsatz EN Tool set FR Kit d'outils ES Set de herramientas HR Garnitura alata HU Szerszámkészlet RO Trusa de scule BG Комплект инструменти



PL



EN



- 1/4":**
- 4, 4.5, 5, 5.5, 6, 7, 8, 9, 10, 11, 12, 13, 14 mm
 - D4, 5, 6, 7, 8, 9, 10 mm
 - 50, 100 mm
 - E4, E5, E6, E7, E8
 - Universal Joint
 - 115 mm
 - 72T
 - Hex Key Wrench:**
 - 1.27 mm x 2, 1.5 mm x 2, 2 mm x 2, 2.5 mm x 2, 3 mm x 2, 4 mm x 2, 5 mm
- 3/8":**
- 10, 11, 12, 13, 14, 15, 16, 17, 18, 19 mm
 - 10, 11, 12, 13, 14, 15 mm
 - E8, E10, E12, E14, E16
 - 18 mm
 - 125 mm
 - Universal Joint
 - 5/16"
 - 72T

- 1/2":**
- 10, 11, 12, 13, 14, 15, 17, 19, 20, 21, 22, 24, 27, 30, 32 mm
 - 16, 17, 18, 19, 22 mm
 - E18, E20, E22, E24
 - 16, 21 mm
 - 125, 250 mm
 - Universal Joint
 - 3 way Adapter
 - Bits Socket: T55, T60
 - 72T
 - 8, 9, 10, 11, 12, 13, 14, 15, 16, 17, 18, 19 mm
 - 5/16"
 - Bits holder
 - 150 mm
 - 150
 - SL4, SL5.5, SL6.5, SL7 mm
 - PH1, PH2, PH3
 - PZ1, PZ2, PZ3
 - T8, T9, T10, T15, T20, T25, T27, T30
 - TT8, TT9, TT10, TT15, TT20, TT25, TT27, TT30
 - H3, H4, H5, H6

- Bits 30 mm:**
- T25, T27x2, T30x2, T35x2, T40x3, T45x2, T50x2
 - H5.5, H6 x2, H7, H8
 - SL6, SL6.5, SL8
 - PH3, PH4
 - PZ3, PZ4
 - M5, M6, M8, M10
- Bits 25 mm:**
- H3, H4, H5, H6
 - H3, H4, H5, H6 (with hole)
 - PH1, PH2
 - PZ1, PZ2
 - T8, T10, T15, T20, T25, T30, T40
 - TT8, TT10, TT15, TT20, TT25, TT30, TT40
 - M5, M6, M8
 - SL4, SL5, SL6, SL8
 - TRI. WING: 1, 2, 3
 - TORQ: 6, 8, 10
 - SQUARE: 1, 2
 - SERVICE: 4, 6, 8

x222 1/4" 3/8" 1/2" AS SYSTEM 72T CrMo CrV

HT1R444	1/4", 3/8", 1/2"	1	2

DE Werkzeugsatz EN Tool set FR Kit d'outils ES Set de herramientas HR Garnitura alata HU Szerszámkészlet RO Trusa de scule BG Комплект инструменти



- 1/2":**
- 10, 11, 12, 13, 14, 15, 17, 19, 20, 21, 22, 24, 27, 30, 32 mm mm
 - Deep Socket: 16, 17, 18, 19, 22 mm
 - E-type Socket: E18, E20, E22, E24
 - Spark Plug Socket: 16, 21 mm
 - Extension Bar: 125, 250 mm
 - Universal Joint
 - 3 way Adapter
 - Bit Socket: T55, T60
 - Ratchet Handle 72T
 - Combination Wrench: 8, 9, 10, 11, 12, 13, 14, 15, 16, 17, 18, 19 mm
 - Bits Holder: 5/16"
- 3/8":**
- Socket: 10, 11, 12, 13, 14, 15, 16, 17, 18, 19 mm
 - Deep Socket: 10, 11, 12, 13, 14, 15 mm
 - E-type Socket: E8, E10, E12, E14, E16
 - Spark Plug Socket 18 mm
 - Extension Bar 125 mm
 - Universal Joint

- Bits Holder: 5/16"
 - Ratchet Handle 72T
- 1/4":**
- Socket: 4, 4.5, 5, 5.5, 6, 7, 8, 9, 10, 11, 12, 13, 14 mm
 - Deep socket: 5, 6, 7, 8, 9, 10 mm
 - Extension Bar: 50, 100 mm
 - E-type Socket: E4, ES, ES, E7, EB
 - Universal Joint
 - Sliding bar 115 mm
 - Ratchet handle 72T
 - Hex Key Wrench: 1.27 mm x 2, 1.5 mm x 2, 2 mm x 2, 2.5 mm x 2, 3 mm x 2, 4 mm x 2, 5 mm
 - Bits holder
 - Screwdriver Handle 1/4"
 - Spinner Handle 1/4"
 - Socket bits:
 - SL4, SL5.5, SL8.5, SL7 mm
 - PH1, PH2, PH3
 - PZ1, PZ2, PZ3
 - T8, T3, T10, T15, T20, T25, T27, T30

- TT8, TT9, TT10, TT18, TT20, TT25, TT27, TT30
- H3, H4, H5, H6
- Bits 30 mm:
 - T25, T27x2, T30x2, T35x2, T40x3, T45x2, T50x2
 - H5.5, H6 x 2, H7, H8
 - SL6, SL6.5, SL8
 - PH3, PH4
 - PZ3, PZ4
 - M5, M6, M8, M10
- Bits 25 mm:
 - H3, H4, H5, H6
 - H3, H4, H5, H6 (with hole)
 - PH1, PH2
 - PZ1, PZ2
 - T8, T9, T10, T15, T20, T25, T27, T30
 - TT8, TT9, TT10, TT15, TT20, TT25, TT27, TT30
 - M5, M6, M8
 - SL4, SL5, SL5.5
 - TRI. WING: 1, 2, 3
 - TORQ: 6, 8, 10
 - SQUARE: 1, 2
 - SERVICE: 4, 6, 8

x222 CrV 1/4" 3/8" 1/2"

HT1R244	1/4", 3/8", 1/2"	1	2

DE Werkzeugsatz EN Tool set FR Kit d'outils ES Set de herramientas HR Garnitura alata HU Szerszámkészlet RO Trusa de scule BG Комплект инструменти

DE Werkzeugsatz EN Tool set FR Kit d'outils ES Set de herramientas HR Garnitura alata HU Szerszámkészlet RO Trusa de scule BG Комплект инструменти



NEW



NEW

1/2":

- 8, 10, 11, 12, 13, 14, 15, 16, 17, 18, 19, 21, 22, 24, 27, 30, 32 mm
- Universal joint
- 3 way adaptor
- 75, 254 mm
- 72T
- 16 mm, 21 mm

1/4":

- 4, 4.5, 5, 5.5, 6, 7, 8, 9, 10, 11, 12, 13, 14 mm
- 50, 100 mm
- 150 mm
- Universal Joint
- 152 mm
- 1/4" bits
- 72T
- 150 mm
- SL 4, SL 5.5, SL 7
- PH1, PH2
- PZ1, PZ2
- T8, T10, T15, T20, T25, T30
- H3, H4, H5, H6

5/16":

- SL 8, SL 10, SL 12
- PH3, PH4
- PZ3, PZ4
- T40, T45, T50, T55
- H8, H10, H12, H14

1/2":

- 14, 15, 16, 17, 18, 19, 20, 22, 24, 27, 30, 32 mm
- 125, 250 mm
- 3 Way Adapter 3/8" F, 1/2" M
- Universal Joint
- 16, 21 mm
- 5/16"
- 72T
- 8, 10, 11, 12, 13, 14, 17, 19, 22 mm
- 1.5, 2.0, 2.5 mm



CrV 1/2" x24

HT1R210 1 1

CrV 1/2" 1/4" x85

HT1R225 1 4

DE Werkzeugsatz EN Tool set FR Kit d'outils ES Set de herramientas HR Garnitura alata HU Szerszámkészlet RO Trusa de scule BG Комплект инструменти

DE Werkzeugsatz EN Tool set FR Kit d'outils ES Set de herramientas HR Garnitura alata HU Szerszámkészlet RO Trusa de scule BG Комплект инструменти



- 1/2":**
- 10, 11, 12, 13, 14, 15, 16, 17, 18, 19, 20, 21, 22, 23, 24, 27, 30, 32 mm
 - 14, 15, 17, 19 mm
 - 72T
 - 125, 250 mm
 - 16, 21 mm
 - 3 Way Adapter
 - 5/16"
 - Universal Joint
- 5/16":**
- 8, 10, 12
 - PH2, PH3
 - PZ3, PZ4
 - T40, T45, T50, T55
 - H8, H10, H12, H14
- 1/4":**
- 4, 5.5, 7 mm
 - PH1, PH2
 - PZ1, PZ2
 - T8, T10, T15, T20, T25, T30
 - H3, H4, H5, H6
 - 4, 4.5, 5, 5.5, 6, 7, 8, 9, 10, 11, 12, 13, 14 mm
 - 6, 7, 8, 9, 10, 11, 12, 13 mm
 - 72T
 - 50, 100 mm
 - 150 mm
 - 30 mm
 - 150 mm
 - 115 mm
 - Universal joint
 - 1.5, 2, 2.5, 3 mm

- 1/4":**
- 4, 5.5, 7
 - PH1, PH2
 - PZ1, PZ2
 - T8, T10, T15, T20, T25, T27, T30
 - H3, H4, H5, H6
 - 4, 4.5, 5, 5.5, 6, 7, 8, 9, 10, 11, 12, 13, 14 mm
 - 6, 7, 8, 9, 10, 11, 12, 13 mm
 - E10, E11, E12, E14, E16, E18, E20, E24
 - 72T
 - 50, 100 mm
 - 150 mm
 - 30 mm
 - 150 mm
 - 115 mm
 - Universal joint
 - 1.27, 1.5, 2, 2.5 mm
- 1/2":**
- 8, 10, 12
 - PH3, PH4
 - PZ3, PZ4
 - T40, T45, T50, T55, T60
 - H7, H8, H10, H12, H14
 - 10, 11, 12, 13, 14, 15, 16, 17, 18, 19, 20, 21, 22, 23, 24, 27, 30, 32 mm
 - 14, 15, 17, 19, 22 mm
 - E10, E11, E12, E14, E16, E18, E20, E24
 - 72T
 - 125, 250 mm
 - 16, 21 mm
 - 3 Way Adapter
 - 5/16" mm
 - Universal Joint

CrV $\frac{1}{2}$ " $\frac{5}{16}$ " $\frac{1}{4}$ " x95

HT1R226 1 4

CrV $\frac{1}{2}$ " $\frac{1}{4}$ " x112













HT1R232 1 4

DE Werkzeugsatz EN Tool set FR Kit d'outils ES Set de herramientas HR Garnitura alata HU Szerszámkészlet RO Trusa de scule BG Комплект инструменти

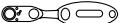

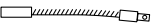

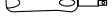
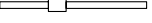
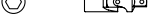

DE Werkzeugsatz EN Tool set FR Kit d'outils ES Set de herramientas HR Garnitura alata HU Szerszámkészlet RO Trusa de scule BG Комплект инструменти

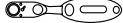

1/4":

-  Slotted: 4, 5.5, 7, 8, 10, 12
-  Phillips: PH1, PH2, PH3
-  Pozidriv: PZ1, PZ2, PZ3
-  Torx: T10, T15, T20, T30, T40
-  Hex: H3, H4, H5, H5, H7, HB
-  Socket: 4, 4.5, 5, 5.5, 6, 7, 8, 9, 10, 11, 12, 13, 14 mm
-  72T Ratchet
-  Extension Bar: 50, 100 mm
-  Flexible Extension Bar: 150 mm
-  Adaptor: 30 mm
-  Spinner handle
-  Sliding bar
-  Universal joint
-  Hex key 1.27, 1.5, 2, 2.5 mm

3/4":

-  Hexagonal Socket: 21, 22, 23, 24, 26, 27, 28, 29, 30, 31, 32, 34, 36, 38, 41, 46, 50 mm
-  Extension Bar 4", 8"
-  24 T Ratchet
-  Sliding T-Bar 500 mm
-  Socket adapter: 3/4" FX1" M
-  Flexible handle 500 mm

1":

-  Hexagonal Socket: 55, 60, 65 mm



x46 CrV 1/4"

HT1R216 1 10



x26 3/4" CrV

HT1R511 3/4" 1 1





DE Werkzeugsatz EN Tool set FR Kit d'outils ES Set de herramientas HR Garnitura alata HU Szerszámkészlet RO Trusa de scule BG Комплект инструменти

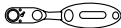
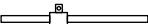

3/4":

-   Hexagonal Socket: 19, 20, 22, 23, 24, 26, 27, 28, 30, 32, 34, 36, 38, 41, 46, 50 mm
-  Extension Bar 4", 8"
-  24 T Ratchet
-  Sliding T-Bar 800 mm

x21	3/4"	CrV
-----	------	-----

			
HT1R510	3/4"	1	1







DE Steckschlüsselsatz mit Umschaltknarre EN Sockets set with ratchet handle FR Jeu de douilles + cliquet ES Juego llaves de vasos + carraca HR Račna s nasadnim ključevima HU Racsnis behajtó kar dugókulcsokkal RO Clichet cu chei tubulare BG Комплект тресчотка и вложки



Ratchet 1/2"
Sockets: 10, 11, 12, 13, 14, 15, 17, 19, 22, 24 mm

	x10	1/2"		72 T	CrV
	CrMo	QUICK RELEASE	ERGO GRIP		





			
HT1R332	1/2"	5	10

DE Steckschlüsselsatz mit Umschaltknarre EN Sockets set with ratchet handle FR Jeu de douilles + cliquet ES Juego llaves de vasos + carraca HR Račna s nasadnim ključevima HU Racsnis behajtó kar dugókulcsokkal RO Clichet cu chei tubulare BG Комплект тресчотка и вложки



Ratchet 1/4"
Sockets: 4, 5, 6, 7, 8, 9, 10, 11, 12, 13 mm

	x10	1/4"		72 T	CrV
	CrMo	QUICK RELEASE	ERGO GRIP		





			
HT1R334	1/4"	5	20

DE Steckschlüsselsatz mit Umschaltknarre EN Sockets set with ratchet handle FR Jeu de douilles + cliquet ES Juego llaves de vasos + carraca HR Račna s nasadnim ključevima kodiranim bojom HU Racsnis behajtó kar színkódos dugókulcsokkal RO Clichete cu chei tubulare cu cod color BG Комплект тресчотка и вложки







Ratchet 1/2"
Sockets: 10, 11, 12, 13, 14, 15, 17, 19, 22, 24 mm

	x10	1/2"		72 T	CrV
	CrMo	QUICK RELEASE	ERGO GRIP		

			
HT1R382	1/2"	5	20

DE Ring Ratschen Steckschlüssel Mit Teile EN Flexible head ratchet wrench with adapters FR Clé à douille à cliquet ES Llaves De Trinquete HR Čegrtaljka s adapterima HU Ratchet csavarkulcs RO Cheie cu clichet BG Тресчотка с адаптори



	x5			
		1/4" x 19mm	3/8" x 19mm	1/2" x 19mm
	72 T	CrV	FLEXIBLE HEAD	

			
HT1R395	1/4", 3/8", 1/2"	8	48



DE Umschaltknarre mit Gelenkkopf EN Swivel Ratchet handle FR Poignée à cliquet pivotant ES Llave de carraca con mango giratorio HR Račna s okretnom ručicom HU Forgókaros racsnis behátó kar RO Clichet cu maner rotativ BG Реверсивна тресчотка

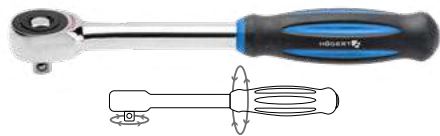

1/4" 60T CrV CrMo
 QUICK RELEASE ERGO GRIP

HT1R374	1/4"	10	50
HT1R372	1/2"	5	20

DE Umschaltknarre EN Ratchet handle FR Poignée à cliquet ES Llave de carraca HR Račna HU Racsnis behátó kar RO Maner cu clichet BG Тресчотка



3/4" CrMo 24 T

HT1R376	3/4"	1	1
---------	------	---	---

DE Umschaltknarre EN Ratchet handle FR Poignée à cliquet ES Llave de carraca HR Račna HU Racsnis behátó kar RO Maner cu clichet BG Тресчотка



1/4" 3/8" 1/2" 72T CrV CrMo
 QUICK RELEASE ERGO GRIP STRAIGHT

HT1R304	1/4"	10	100
HT1R308	3/8"	10	50
HT1R302	1/2"	10	30

DE Umschaltknarre EN Ratchet handle FR Poignée à cliquet ES Llave de carraca HR Račna HU Racsnis behátó kar RO Maner cu clichet BG Тресчотка



1/4" 3/8" 1/2" 72T CrV CrMo QUICK RELEASE ERGO GRIP

HT1R324	1/4"	10	50
HT1R328	3/8"	5	30
HT1R322	1/2"	5	25

DE Umschaltknarre EN Ratchet handle FR Poignée à cliquet ES Llave de carraca HR Račna HU Racsnis behátó kar RO Maner cu clichet BG Тресчотка



1/4" 1/2" 72T TPR CrMo
 QUICK RELEASE ERGO GRIP

HT1R354	1/4"	12	72
HT1R352	1/2"	6	24

DE Teleskop-Umschaltknarre EN Telescopic ratchet handle FR Clé à Douille à Cliquet télescopique ES Llave de carraca telescópica HR Teleskopska račna HU Teleszkópos racsnis behátó kar RO Clichet telescopic BG Телескопична тресчотка



1/2" 72T 300-450 mm CrV CrMo QUICK RELEASE ERGO GRIP

HT1R342	1/2"	5	25
---------	------	---	----

DE Umschaltknarre EN Ratchet handle FR Poignée à cliquet ES Llave de carraca HR Račna HU Racsnis behátó kar RO Maner cu clichet BG Тресчотка



1/4" 72T CrV CrMo ERGO GRIP

HT1R391	1/4"	10	100
---------	------	----	-----

DE Drehmomentschlüssel EN Torque wrench FR Clé dynamométrique ES Llave dinamo-métrica HR Momentni ključ HU Nyomaték kulcs RO Cheie dinamometrica BG Ключ динамометричен



24T ± 4% CrV

HT1W701	1/4"	5-25 Nm	1	12
HT1W706	1/2"	20-110 Nm	1	12
HT1W707	1/2"	40-210 Nm	1	12
HT1W708	1/2"	50-350 Nm	1	12

DE Drehmomentschlüssel EN Torque wrench FR Clé dynamométrique ES Llave dinamométrica HR Momentni kluč HU Nyomaték kulcs RO Cheie dinamometrica BG Ключ динамометричен



Folder		Scale	Length	Box	Case
HT1W710	1/4"	5-25 Nm	255 mm	1	6
HT1W711	3/8"	10-60 Nm	320 mm	1	6
HT1W712	1/2"	20-120 Nm	435 mm	1	6
HT1W713	1/2"	40-220 Nm	515 mm	1	6
HT1W714	1/2"	60-330 Nm	595 mm	1	6



DE Spinner Griff EN Spinner handle FR Rallonge avec manche ES Destornillador para llaves de vaso HR Okretna ručka za nasadne ključeva HU Dugókulcs behajtó kar RO Adapter pentru chei tubulare BG Отвертка за вложки



Folder	Length	Box	Case
HT1S203	150 mm	10	100

DE Steckschlüssel gebogen EN L-type wrench set FR Jeu de clés de type L ES Juego de llaves tipo "L" HR Set L ključeva HU L-típusú csavarkulcs készlet RO Set chei tip L BG Комплект гаечни ключове тип L



Folder	Box	Case
HT1R501	1	4

DE Steckschlüsselsatz EN Socket Wrench Set FR Coffret de clés à douilles ES Juego de llaves de vaso HR Set nasadnih ključeva HU Dugókulcs készlet RO Set de chei tubulare BG Комплект глухи ключове



8, 9, 10, 11, 12, 13, 14, 15, 16, 17, 18, 19, 20, 21, 22, 24, 27, 30, 32, 34, 36 mm

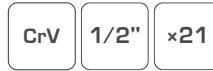

Folder	Box	Case
HT4R085	1	5

DE Steckschlüsselsatz EN Socket Wrench Set FR Coffret de clés à douilles ES Juego de llaves de vaso HR Set nasadnih ključeva HU Dugókulcs készlet RO Set de chei tubulare BG Комплект глухи ключове



10, 12, 13, 15, 17, 19, 22, 24 mm

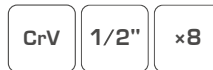

Folder	Box	Case
HT4R083	5	20

DE Steckschlüsselsatz EN Socket Wrench Set FR Coffret de clés à douilles ES Juego de llaves de vaso HR Set nasadnih ključeva HU Dugókulcs készlet RO Set de chei tubulare BG Комплект глухи ключове



10, 12, 13, 15, 17, 19, 22, 24 mm

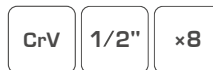

Folder	Box	Case
HT4R050	5	10

DE Steckschlüsselsatz EN Socket Wrench Set FR Coffret de clés à douilles ES Juego de llaves de vaso HR Set nasadnih ključeva HU Dugókulcs készlet RO Set de chei tubulare BG Комплект глухи ключове



10, 12, 13, 15, 17, 19, 22, 24 mm

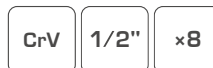

Folder	Box	Case
HT4R051	5	10

DE Steckschlüsselsatz EN Socket Wrench Set FR Coffret de clés à douilles ES Juego de llaves de vaso HR Set nasadnih ključeva HU Dugókulcs készlet RO Set de chei tubulare BG Комплект глухи ключове



10, 12, 13, 15, 17, 19, 22, 24 mm

CrV 1/2" x8

HT4R084	5	20

DE Steckschlüssel gebogen EN L-type wrench set FR Jeu de clés de type L ES Juego de llaves tipo "L" HR Set L ključeva HU L-típusú csavarkulcs készlet RO Set de chei tip L BG Комплект гаечни ключове тип L



x9 CrV

HT1R500	1	8

DE Verlängerung für Steckschlüssel EN Extension bar FR Rallonge de clé ES Alargador HR Produžetak za nasadne ključeve HU Hosszabbító kar RO Extensie BG Удължител за вложки



1/4" CrV DIN 3123

HT1A701	50 mm	50	500
HT1A702	76 mm	40	400
HT1A703	100 mm	25	250
HT1A705	152 mm	20	200

DE Verlängerung für Steckschlüssel EN Extension bar FR Rallonge de clé ES Alargador HR Produžetak za nasadne ključeve HU Hosszabbító kar RO Extensie BG Удължител за вложки



3/8" CrV DIN 3123

HT1A714	127 mm	20	80

DE Verlängerung für Steckschlüssel EN Extension bar FR Rallonge de clé ES Alargador HR Produžetak za nasadne ključeve HU Hosszabbító kar RO Extensie BG Удължител за вложки



3/4" CrV

HT1A733	101 mm	1	1
HT1A736	203 mm	1	1

DE Verlängerung für Steckschlüssel EN Extension bar FR Rallonge de clé ES Alargador HR Produžetak za nasadne ključeve HU Hosszabbító kar RO Extensie BG Удължител за вложки



1/2" CrV DIN 3123

HT1A724	125 mm	20	100
HT1A727	250 mm	10	40

DE Elastische Verlängerung für Steckschlüssel EN Flexible extension bar FR Rallonge de clé ES Alargador flexible HR Produžetak za nasadne ključeve, fleksibilan HU Mechanikai szerszámok RO Extensie flexibilă BG Удължител за вложки, гъвкав



1/4" FLEXIBLE CrV

HT1A740	150 mm	20	200

DE L-Knarre für Steckschlüssel EN Handle for wrench socket L-shape FR Cle Type L ES Llave tipo L HR Okretna ručka L-tipa HU L-alakú toldó markolat RO Chei tubulare cu maner de prelungire tip L BG Г-образен върток за вложки



1/2" CrV DIN 3122

HT1A792	250 mm	10	40

DE Drehgriff Typ "T" EN Sliding T-bar FR Poignée coulissante en T ES Mango deslizante en T HR Okretna ručka T-tipa HU Csúsztatható T-rúd RO Bara tip T glisant BG Върток за вложка тип T



1/4"
1/2" CrV DIN 3122

Folder	Length	Weight	Quantity	Box
HT1A745	1/4"	152 mm	25	200
HT1A747	1/2"	255 mm	10	50

DE Steckschlüssel EN Socket wrench FR Clé à douille ES Pistikupesa vöti HR Nasadni ključ RO Cheie tubulară HU Csőkulcs BG Гневен ключ



CrV HEX 300 mm

Folder	Length	Weight	Quantity	Box
HT1W633	8 mm	300 mm	17	60
HT1W634	10 mm	300 mm	17	60
HT1W635	12 mm	300 mm	17	60
HT1W636	13 mm	300 mm	17	60
HT1W637	15 mm	300 mm	42	30
HT1W638	17 mm	300 mm	34	30
HT1W639	19 mm	300 mm	34	30

DE Drehgriff Typ "T" EN Sliding T-bar FR Poignée coulissante en T ES Mango deslizante en T HR Okretna ručka T-tipa HU Csúsztatható T-rúd RO Bara tip T glisant BG Върток за вложка тип T



3/4" CrV

Folder	Length	Weight	Quantity	Box
HT1A748	500 mm		2	8

DE Steckschlüssel-Hebel mit Gelenk EN Flexible handle FR Rallonge de clé Flexible ES Alargador de llave flexible HR Nagibna okretna ručka HU Rugalmas markolat RO Maner flexibil BG Върток за вложка с плъзгаща дръжка



3/4" CrV

Folder	Length	Weight	Quantity	Box
HT1A745	500 mm		1	200

DE Steckschlüssel-Hebel mit Gelenk EN Flexible handle FR Rallonge de clé Flexible ES Alargador de llave flexible HR Nagibna okretna ručka HU Rugalmas markolat RO Maner flexibil BG Върток за вложка с плъзгаща дръжка



1/2" CrV DIN 3121

Folder	Length	Weight	Quantity	Box
HT1A763	380 mm		5	200
HT1A764	457 mm		5	200

DE Verlängerung für Steckschlüssel EN Universal joint FR Joint universel ES Adaptador Vaso Universal HR Univerzalni spoj za nasadne ključeve HU Univerzális csatlakozó elem dugókulcsokhoz RO Legatura universală pentru chei tubulare BG Кардан за вложка



1/4"
3/8"
1/2" CrV DIN 3123

Folder	Length	Weight	Quantity	Box
HT1A755	1/4"		25	500
HT1A756	3/8"		20	200
HT1A757	1/2"		25	200

DE Adapter EN Socket adapter FR Adaptateur douille ES Adaptador para vasos HR Adapter HU Adapter RO Adapter BG Адаптор



CrV DIN 3121

Folder	Length	Weight	Quantity	Box
HT1A770	F1/4" x M3/8"		50	500
HT1A771	F3/8" x M1/4"		25	250
HT1A772	F3/8" x M1/2"		25	250
HT1A773	F1/2" x M3/8"		20	200
HT1A774	F1/2" x M3/4"		10	100
HT1A775	F3/4" x M1/2"		10	100

DE Langer Steckschlüsselsatz für Leichtmetallfelgen EN Long socket set for alloy wheels FR Jeu de douilles longues pour jantes alliage ES Juego de vasos largos para llantas de aleación HR Set dugih utičnica za aluminijske naplatke HU Hosszú foglalkészlet könnyűfém keréktárcsákhoz RO Set prize lungi pentru jante din aliaj BG Комплект дълги гнезда за лети джанти



x3 1/2" 17 mm 19 mm 21 mm CrMo
LONG ALLOY WHEEL LONG



Folder	Length	Weight	Quantity	Box
HT4R106	1/2"	150 mm	1	10

DE Langer Steckschlüsselsatz für Leichtmetallfelgen **EN** Long socket set for alloy wheels **FR** Jeu de douilles longues pour jantes alliage **ES** Juego de vasos largos para llantas de aleación **HR** Set dugih utičnica za aluminijske naplatke **HU** Hosszú foglalkészlet könnyűfém keréttárcsához **RO** Set prize lungi pentru jante din aliaj **BG** Комплект дълги гнезда за лети джанти



x3	1/2"	17 mm 19 mm 21 mm	CrMo	ALLOY WHEEL				
					HT4R107	1/2"	1	20

DE Satz Köpfe für beschädigte Schrauben und Muttern **EN** Wheel intervention socket set **FR** Jeu de douilles d'intervention de roue **ES** Juego de vasos de intervención de rueda **HR** Set interventivnih utičnica za kotače **HU** Kerékbeavatkozó aljzat készlet **RO** Set prize interventie roti **BG** Комплект гнезда за интервенция на колела



x10	1/2"	FLIP SOCKET	CrMo					
					HT4R108	1/2"	1	10

DE Satz Schlag-Stecknüsse **EN** Impact Socket Set **FR** Coffret de douilles à chocs **ES** Juego de vasos de impacto **HR** Set udarnih nasadnih ključeva **HU** Ütvecsavarfej készlet **RO** Set de tubulare de impact **BG** Комплект ударни вложки



1/2" short:
10, 12, 13, 15, 17, 19, 21, 22, 24 mm
1/2" long:
17, 19, 21 mm

CrV	1/2"	x12			
			HT4R052	1	8

DE Schlagschrauber-Steckschlüssel, kurz **EN** Impact socket, short **FR** Douille à choc impact, court **ES** Llave de impacto, corto **HR** Udarni nasadni ključ, kratak **HU** Pneumatikus dugókulcsok, rövid **RO** Chei de impact, mic de statura **BG** Ударна вложка къс



1/2"	SHORT	CrMo	DIN 3121
------	-------	------	----------

	∅		
HT4R060	10 mm	20	120
HT4R061	11 mm	20	120
HT4R062	12 mm	20	120
HT4R063	13 mm	20	120
HT4R064	14 mm	20	80
HT4R065	15 mm	20	120
HT4R066	16 mm	20	120
HT4R067	17 mm	12	96
HT4R068	18 mm	12	96
HT4R069	19 mm	12	96
HT4R070	20 mm	12	96
HT4R071	21 mm	12	96
HT4R072	22 mm	10	80
HT4R074	24 mm	10	80
HT4R077	27 mm	8	48
HT4R080	30 mm	8	48
HT4R081	32 mm	8	48

DE Schlagschrauber-Steckschlüssel **EN** Impact socket, deep **FR** Douille à choc impact, longue **ES** Llave de impacto, larga **HR** Udarni nasadni ključ **HU** Pneumatikus dugókulcs **RO** Chei tubulare pneumatice de impact **BG** Ударна дълга вложка



1/2"	DEEP	CrMo	DIN 3121
------	------	------	----------

HT4R010	10 mm	18	108
HT4R011	11 mm	18	108
HT4R012	12 mm	18	108
HT4R013	13 mm	18	108
HT4R014	14 mm	18	108
HT4R015	15 mm	18	108
HT4R016	16 mm	18	108
HT4R017	17 mm	14	84
HT4R018	18 mm	14	84
HT4R019	19 mm	14	84
HT4R020	20 mm	14	84
HT4R021	21 mm	14	84
HT4R022	22 mm	12	72
HT4R023	23 mm	8	48
HT4R024	24 mm	8	48
HT4R027	27 mm	6	36
HT4R030	30 mm	6	36
HT4R032	32 mm	6	36

DE Schlagschrauber-Steckschlüssels und Verlängerung **EN** Flip Impact socket set **FR** Jeu de douilles à choc bilatérales et de rallonges **ES** Juego de llaves de impacto de dos caras y prolongadores **HR** Garnitura udarnih nasadnih ključeva, dvostranih **HU** Kétoldalú pneumatikus dugókulcs készlet **RO** Trusa de chei tubulare cu doua capete **BG** Комплект ударни вложки, двустрани с удължител



x3	1/2"	17 mm 19 mm 22 mm	75 mm	SUPER SLIM	CrMo			
					HT4R006	5	20	

DE Schlagschrauber-Steckschlüssels **EN** Impact socket set, thin wall **FR** Jeu de douilles à chocs **ES** Juego de llaves de impacto **HR** Garnitura udarnih nasadnih ključeva **HU** Hosszú pneumatikus dugókulcs készlet **RO** Trusa de chei tubulare lungi de impact **BG** Комплект ударни вложки thin wall



x3	1/2"	17 mm 19 mm 21 mm	78 mm	SUPER SLIM	CrMo			
					HT4R105	12	24	

DE Schlagschrauber-Steckschlüssels **EN** Impact socket set, deep **FR** Jeu de douilles à choc impact, longues **ES** Juego de llaves de impacto, largas **HR** Garnitura udarnih nasadnih ključeva **HU** Hosszú pneumatikus dugókulcs készlet **RO** Trusa de chei tubulare lungi de impact **BG** Комплект дълги ударни вложки



10, 12, 13, 14, 15,
16, 17, 18, 19, 21, 22,
24, 27, 30, 32 mm



x15	1/2"	DEEP	CrMo	DIN 3121			
					HT4R049	1	4

DE Schlagschrauber-Steckschlüssel, kurz EN Impact socket, short FR Douille à choc impact, court ES Llave de impacto, corto HR Udarni nasadni ključ, kratak HU Pneumatikus dugókulcsok, rövid RO Chei de impact, mic de statura BG Ударна вложка къс



3/4" SHORT CrMo DIN 3121

	∅	▢	📦
HT4R141	19 mm	16	64
HT4R142	21 mm	16	64
HT4R143	22 mm	16	64
HT4R144	24 mm	16	64
HT4R145	27 mm	16	64
HT4R146	30 mm	12	48
HT4R147	32 mm	12	48
HT4R148	33 mm	8	32
HT4R149	34 mm	8	32
HT4R151	36 mm	6	24
HT4R152	38 mm	6	24
HT4R153	41 mm	4	16
HT4R154	46 mm	4	16
HT4R155	50 mm	2	8
HT4R156	55 mm	2	8
HT4R157	60 mm	2	8
HT4R158	65 mm	2	8

DE Schlagschrauber-Steckschlüssel, lang EN Impact socket, deep FR Douille à choc impact, longue ES Llave de impacto, larga HR Udarni nasadni ključ HU Pneumatikus dugókulcsok RO Chei de impact BG Ударна вложка дълга



3/4" DEEP CrMo DIN 3121

	▢	▢	📦
HT4R111	19 mm	6	24
HT4R112	21 mm	6	24
HT4R113	24 mm	6	24
HT4R114	27 mm	6	24
HT4R115	30 mm	6	24
HT4R116	32 mm	6	24
HT4R120	36 mm	6	24
HT4R122	41 mm	4	16
HT4R124	46 mm	4	16

DE Schlagschrauber-Steckschlüssel, lang EN Impact socket, deep FR Douille à choc impact, longue ES Llave de impacto, larga HR Udarni nasadni ključ HU Pneumatikus dugókulcsok RO Chei de impact BG Ударна вложка дълга



1" DEEP CrMo DIN 3121

	▢	▢	📦
HT4R211	27 mm	4	16
HT4R212	30 mm	4	16
HT4R213	32 mm	4	16
HT4R214	33 mm	4	16
HT4R217	36 mm	4	16

DE Schlag-Verlängerung EN Impact extension bar FR Extension rallonge à choc ES Prolongador llave de impacto HR Udarni produžetak HU Pneumatikus toldó adapter RO Prelungitor pentru chei tubulare de impact BG Ударен удължител



1/2" CrMo DIN 3121

	▢	▢	📦
HT4R302	75 mm	20	120
HT4R304	125 mm	20	80
HT4R306	250 mm	20	40

DE Schlag-Verlängerung EN Impact extension bar FR Extension rallonge à choc ES Prolongador llave de impacto HR Udarno proširenje HU Pneumatikus toldó RO Extensii de impact BG Ударен удължител



CrMo 3/4" DIN 3121

	▢	▢	📦
HT4R310	175 mm	4	16
HT4R311	250 mm	4	16

DE Schlag-Verlängerung EN Impact extension bar FR Extension rallonge à choc ES Prolongador llave de impacto HR Udarno proširenje HU Pneumatikus toldó RO Extensii de impact BG Ударен удължител



CrMo 1" DIN 3121

	▢	▢	📦
HT4R321	250 mm	3	12

DE Schlagadapter EN Impact adapter FR Adaptateur à choc ES Adaptador para llave de impacto HR Udarni adapter HU Pneumatikus adapter RO Adaptor de impact BG Ударен адаптер



CrMo DIN 3121

	▢	▢	📦
HT4R323	3/4" (F) x 1" (M)	12	72
HT4R325	3/4" (F) x 1/2" (M)	6	24

DE Schlagadapter EN Impact adapter FR Adaptateur à choc ES Adaptador para llave de impacto HR Udarni adapter HU Pneumatikus adapter RO Adaptor de impact BG Ударен адаптер



CrMo DIN 3121 F 1/2" x M 3/4"

	▢	▢	📦
HT4R324	F 1/2" x M 3/4"	14	84

DE Schlagschrauber-Gelenk EN Impact universal joint FR Rotule universelle
ES Rótula de bola universal HR Kuglasti zglob HU Golyós kulcs adapter RO Adaptor cu
bita BG Универсален кардан



CrMo 1/2" DIN 3121

HT4R328	67 mm	10	50

DE Druckluft-Schlagschrauber-Nuss Torx EN Bit impact socket torx set FR Jeu de
8 douilles à chocs Torx ES Juego de llaves de impacto, Torx HR Pinski ključevi torx,
udarni HU Pneumatikus torx bit kulcsok RO Chei bit de impact torx BG Комплект
вложки ударни torx



T30, T40, T45, T50,
T55, T60, T70, T80



CrMo 1/2" x8

HT6R002	1	10

DE Druckluft-Schlagschrauber-Nuss Hex EN Bit impact socket hex set FR Jeu de
8 douilles à chocs Hex ES Juego de llaves de impacto, Hex HR Pinski ključevi hex,
udarni HU Pneumatikus hex bit kulcsok RO Chei bit de impact hex BG Комплект
вложки ударни hex



H6, H7, H8, H10, H12,
H14, H17, H19



CrMo 1/2" x8

HT6R004	1	10

DE Druckluft-Schlagschrauber-Nuss Spline EN Bit impact socket spline set FR Jeu
de 8 douilles à chocs Spline ES Juego de llaves de impacto Spline HR Pinski ključevi
spline, udarni HU Pneumatikus bit kulcs készlet RO Trusa de chei bit de impact
BG Комплект вложки ударни spline



M5, M6, M8, M10, M12,
M14, M16, M18



CrMo 1/2" x8

HT6R006	1	10

DE Torx-Schlagschrauber-Steckschlüssel EN Torx impact socket FR Douille à chocs
Torx ES Tomas de impacto Torx HR Torx udarna utičnica HU Torx ütvecsavaros
dugókulcs RO Priză de impact Torx BG Ударно гнездо „Torx”



CrMo TORX 1/2"

HT4R033	T70	20	100
HT4R034	T60	20	100
HT4R035	T55	20	100
HT4R036	T50	20	100
HT4R037	T45	20	100
HT4R038	T40	20	100
HT4R039	T30	20	100
HT4R040	T25	20	100
HT4R041	T20	20	100

DE Sechskantsteckschlüssel EN Socket, hexagon metric FR Douille 6 pans ES Llave de
vaso hexagonal HR Šesterokutni nasadni ključ HU Hatszög dugókulcs RO Chei tubu-
lare hexagonale BG Вложка шестостенна



1" CrV

HT1A547	55 mm	2	8
HT1A548	60 mm	2	8
HT1A549	65 mm	2	8

DE Adapter EN Socket adapter FR Adaptateur douille ES Reducción HR Adapter
RO Adaptor priză HU Aljzat adapter BG Адаптер за контакт



CrV 3/4"-1"
1"

HT1A777	3/4"-1"	10	40

DE Sechskantsteckschlüssel EN Socket, hexagon metric FR Douille 6 pans ES Llave de vaso hexagonal HR Šesterokutni nasadni ključ HU Hatszög dugókulcs RO Chei tubulare hexagonale BG Вложка шестостенна



Folder	Symbol	Hexagon	Length	Weight	Quantity
HT1A509	3/4"	19 mm	8	64	
HT1A510	3/4"	20 mm	8	64	
HT1A511	3/4"	21 mm	8	64	
HT1A512	3/4"	22 mm	8	64	
HT1A513	3/4"	23 mm	8	64	
HT1A514	3/4"	24 mm	8	64	
HT1A516	3/4"	26 mm	8	64	
HT1A517	3/4"	27 mm	8	64	
HT1A518	3/4"	28 mm	8	64	
HT1A520	3/4"	30 mm	8	64	
HT1A521	3/4"	31 mm	6	24	
HT1A522	3/4"	32 mm	6	24	
HT1A524	3/4"	34 mm	6	24	
HT1A526	3/4"	36 mm	6	24	
HT1A528	3/4"	38 mm	6	24	
HT1A531	3/4"	41 mm	4	16	
HT1A536	3/4"	46 mm	4	16	
HT1A540	3/4"	50 mm	2	16	
HT1A545	1"	55 mm	-	-	

CrV

DE Sechskantsteckschlüssel EN Socket, hexagon metric FR Douille hexagonales ES Llave de vaso hexagonal HR Šesterokutni nasadni ključ HU Hatszög dugókulcs RO Chei tubulare hexagonale BG Вложка шестостенна

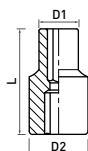

Folder	Symbol	Hexagon	Length	Weight	Quantity
HT1A002	4	6,8	11,8	25	500
HT1A003	4,5	7,2	11,8	25	500
HT1A004	5	8	11,8	25	500
HT1A005	5,5	8,5	11,8	25	500
HT1A006	6	9,2	11,8	25	500
HT1A007	7	10,8	11,8	25	500
HT1A008	8	11,8	11,8	25	500
HT1A009	9	12,8	12,8	25	500
HT1A010	10	14,5	14,5	25	400
HT1A011	11	15,8	15,8	25	500
HT1A012	12	16,8	16,8	25	400
HT1A013	13	17,8	17,8	25	400
HT1A014	14	19,8	19,8	25	400

1/4"

6 PT

AS SYSTEM

CrV

DIN 3124

DE Sechskantsteckschlüssel lang EN Socket, hexagon metric, deep FR Douille Hexagonale allongée ES Llave de vaso hexagonal larga HR Šesterokutni nasadni ključ HU Hatszög dugókulcs RO Chei tubulare hexagonale BG Вложка шестостенна, дълга

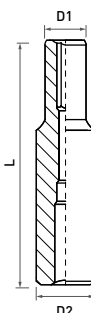

3/8"

6 PT

LONG

AS SYSTEM

CrV

DIN 3124

Folder	Symbol	Hexagon	Length	Weight	Quantity
HT1A156	6 mm	10,3 mm	16,8 mm	64 mm	30 240
HT1A157	7 mm	10,8 mm	16,8 mm	64 mm	30 240
HT1A158	8 mm	12 mm	16,8 mm	64 mm	30 240
HT1A159	9 mm	13,3 mm	16,8 mm	64 mm	30 240
HT1A160	10 mm	14,5 mm	16,8 mm	64 mm	30 240
HT1A161	11 mm	16,8 mm	16,8 mm	64 mm	30 240
HT1A162	12 mm	17,8 mm	17,8 mm	64 mm	30 240
HT1A163	13 mm	18,8 mm	18,8 mm	64 mm	30 240
HT1A164	14 mm	19,8 mm	19,8 mm	64 mm	25 200
HT1A165	15 mm	21,8 mm	21,8 mm	64 mm	20 160
HT1A166	16 mm	21,8 mm	21,8 mm	64 mm	20 160
HT1A167	17 mm	23,8 mm	23,8 mm	64 mm	15 120
HT1A168	18 mm	25,8 mm	25,8 mm	64 mm	15 120
HT1A169	19 mm	25,8 mm	25,8 mm	64 mm	15 120
HT1A170	20 mm	27,8 mm	27,8 mm	64 mm	10 80
HT1A171	21 mm	27,8 mm	27,8 mm	64 mm	10 80

DE Sechskantsteckschlüssel EN Socket, hexagon metric FR Douille 6 pans ES Llave de vaso hexagonal HR Šesterokutni nasadni ključ HU Hatszög dugókulcs RO Chei tubulare hexagonale BG Вложка шестостенна

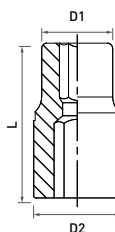

1/2"

6 PT

AS SYSTEM

CrV

DIN 3124

Folder	Symbol	Hexagon	Length	Weight	Quantity
HT1A208	8 mm	13,7 mm	21,8 mm	38 mm	20 200
HT1A209	9 mm	14,2 mm	21,8 mm	38 mm	20 200
HT1A210	10 mm	15,3 mm	21,8 mm	38 mm	20 200
HT1A211	11 mm	16,5 mm	21,8 mm	38 mm	20 200
HT1A212	12 mm	17,8 mm	21,8 mm	38 mm	20 200
HT1A213	13 mm	19,0 mm	21,8 mm	38 mm	20 200
HT1A214	14 mm	20,3 mm	21,8 mm	38 mm	20 200
HT1A215	15 mm	21,8 mm	20,5 mm	38 mm	20 200
HT1A216	16 mm	21,8 mm	20,5 mm	38 mm	20 200
HT1A217	17 mm	23,8 mm	21,8 mm	38 mm	20 200
HT1A218	18 mm	25,8 mm	22,8 mm	38 mm	10 200
HT1A219	19 mm	25,8 mm	22,8 mm	38 mm	10 100
HT1A220	20 mm	27,8 mm	23,8 mm	38 mm	10 100
HT1A221	21 mm	27,8 mm	23,8 mm	38 mm	20 200
HT1A222	22 mm	29,8 mm	26 mm	38 mm	10 100
HT1A223	23 mm	31,8 mm	28 mm	39 mm	20 200
HT1A224	24 mm	31,8 mm	28 mm	39 mm	10 100
HT1A227	27 mm	35,8 mm	30 mm	42 mm	5 50
HT1A230	30 mm	39,8 mm	34 mm	44 mm	5 50
HT1A232	32 mm	41,8 mm	36 mm	44 mm	5 50
HT1A236	36 mm	45,8 mm	48 mm	44 mm	5 50

DE Sechskantsteckschlüssel EN Socket, hexagon metric FR Douille 6 pans ES Llave de vaso HR Šesterokutni nasadni ključ HU Hatszög dugókulcs RO Chei tubulare hexagonale BG Вложка шестостенна

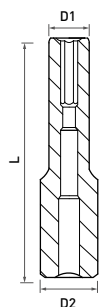

1/2" 6 PT LONG
AS SYSTEM CrV DIN 3124

	⊘	D1	D2	L		
HT1A258	8 mm	14,8 mm	21,8 mm	78 mm	20	160
HT1A259	9 mm	15,3 mm	21,8 mm	78 mm	20	160
HT1A260	10 mm	15,3 mm	21,8 mm	78 mm	20	160
HT1A261	11 mm	16,5 mm	21,8 mm	78 mm	20	160
HT1A262	12 mm	17,8 mm	21,8 mm	78 mm	20	160
HT1A263	13 mm	19,0 mm	21,8 mm	78 mm	15	120
HT1A264	14 mm	20,0 mm	21,8 mm	78 mm	15	120
HT1A265	15 mm	21,8 mm	21,8 mm	78 mm	15	120
HT1A266	16 mm	21,8 mm	21,8 mm	78 mm	15	120
HT1A267	17 mm	23,8 mm	23,8 mm	78 mm	15	120
HT1A268	18 mm	25,8 mm	25,8 mm	78 mm	15	120
HT1A269	19 mm	25,8 mm	25,8 mm	78 mm	15	120
HT1A270	20 mm	27,8 mm	27,8 mm	78 mm	10	80
HT1A271	21 mm	27,8 mm	27,8 mm	78 mm	10	80
HT1A272	22 mm	29,8 mm	29,8 mm	78 mm	10	80
HT1A273	23 mm	31,8 mm	31,8 mm	78 mm	10	80
HT1A274	24 mm	31,8 mm	31,8 mm	78 mm	10	80
HT1A277	27 mm	35,8 mm	35,8 mm	78 mm	8	64
HT1A280	30 mm	39,8 mm	39,8 mm	78 mm	6	48
HT1A282	32 mm	41,8 mm	41,8 mm	78 mm	6	48

DE Steckschlüssel Spline EN Spline socket FR Douille spline 1/2", 8 mm, ES Llave de vaso Spline 1/2", 8 mm, CrV50BV30, DIN 3121 HR Nasadni ključ spline HU Spline dugókulcsok RO Chei tubulare spline BG Вложка тип Spline

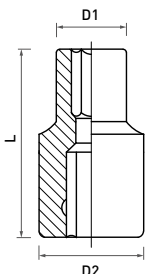

1/2" SPLINE CrV
DIN 3124

	⊘	D1	D2	L		
HT1A408	8 mm	13,7 mm	21,8 mm	38 mm	20	200
HT1A409	9 mm	14,2 mm	21,8 mm	38 mm	20	200
HT1A410	10 mm	15,3 mm	21,8 mm	38 mm	20	200
HT1A411	11 mm	16,5 mm	21,8 mm	38 mm	20	200
HT1A412	12 mm	17,8 mm	21,8 mm	38 mm	20	200
HT1A413	13 mm	19,0 mm	21,8 mm	38 mm	20	200
HT1A414	14 mm	20,3 mm	21,8 mm	38 mm	20	200
HT1A415	15 mm	21,8 mm	20,5 mm	38 mm	20	200
HT1A416	16 mm	21,8 mm	20,5 mm	38 mm	20	200
HT1A417	17 mm	23,8 mm	21,8 mm	38 mm	20	200
HT1A418	18 mm	25,8 mm	22,8 mm	38 mm	10	100
HT1A419	19 mm	25,8 mm	22,8 mm	38 mm	10	100
HT1A420	20 mm	27,8 mm	23,8 mm	38 mm	10	100
HT1A421	21 mm	29,8 mm	26,0 mm	38 mm	10	100
HT1A422	22 mm	29,8 mm	26,0 mm	38 mm	10	100
HT1A423	23 mm	31,8 mm	28,0 mm	38 mm	10	100
HT1A424	24 mm	33,8 mm	28,5 mm	40 mm	10	100
HT1A427	27 mm	35,8 mm	30,0 mm	42 mm	5	50
HT1A430	30 mm	39,8 mm	34,0 mm	44 mm	5	50
HT1A432	32 mm	41,8 mm	36,0 mm	44 mm	5	50

DE Sechskant Zündkerzensteckschlüssel EN Hexagon spark plug socket FR Douille pour bougie ES Llave de vaso HR Nasadni ključ za svjećice HU Gyújtógyertya kulcs RO Chei pentru bujii BG Вложка шестостенна за свещи

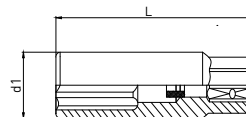

3/8" 6 PT CrV DIN 3120

	⊘	D1	L		
HT1A779	16 mm	21,8 mm	64 mm	20	160

DE Sechskant Zündkerzensteckschlüssel EN Hexagon spark plug socket FR Douille pour bougies d'allumage ES Vaso bujía HR Nasadni ključ za svjećice HU Gyújtógyertya kulcs RO Chei tubulare pentru bujii BG Вложка за свещи

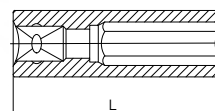

1/2" 6 PT CrV DIN 3120

	⊘	D1	L		
HT1A783	16 mm	21,8 mm	64 mm	20	200
HT1A785	21 mm	27,8 mm	65 mm	10	100

DE Steckschlüsselsatz EN Deep socket set FR Jeu de douilles ES Llaves de vaso HR Komplet šesterokutnih nasadnih ključeva HU Hatszög dugókulcs készlet RO Set de chei tubulare hexagonale BG Комплект вложки



⊘ 5,5, 6, 7, 8, 9, 10, 12, 13 mm

8 x 1/4" 6 PT LONG
AS SYSTEM CrV DIN 3124

HT1A886	50 mm	5	40

DE Steckschlüsselsatz EN Deep socket set FR Jeu de douilles ES Llaves de vaso HR Komplet šesterokutnih nasadnih ključeva HU Hatszög dugókulcs készlet RO Set de chei tubulare hexagonale BG Комплект вложки



⊘ 10, 12, 13, 14, 15, 17, 19, 21, 22, 24 mm

10 x 1/2" 6 PT LONG
AS SYSTEM CrV DIN 3124

HT1A888	76 mm	5	10

DE Spitzenset torx EN Torx bit socket set FR Kit de torx ES Juego de Llaves torx HR Komplet nasadnih ključeva torx HU Torx dugókulcs készlet RO Set de chei tubulare torx BG Комплект вложки тип torx



- 1/4": E5, E6, E7, E8
- 3/8": E10, E12, E14, E16
- 1/4" M x 3/8" F

	3/8" 1/4"		CrV				
				HT1A884	E5-E16	5	20

DE Spitzenset torx EN Torx bit socket set FR Kit de torx ES Juego de Llaves torx HR Komplet nasadnih ključeva torx HU Torx dugókulcs készlet RO Set de chei tubulare torx BG Комплект вложки тип torx



- 1/2": E10, E11, E12, E14, E16, E18, E20, E22, E24

	1/2"		CrV				
				HT1A880	E10-E24	5	20

DE Adapter für Bits EN Bit adapter FR Adaptateur de bit ES Adaptador de punta de HR Adapter za bitove HU Bitfej adapter RO Adapter pentru biti BG Адаптор за битове



1/4"	CrV				
		HT1A752	1/4"	25	500

DE PH Stiftschlüssel EN PH Impact bit socket FR Clef mâle PH ES Llave de vaso con punta PH HR Držač bitova PH HU PH pneumatikus bitfej készlet RO Biti de impact PH BG Бит вложка PH

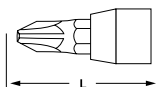

	1/4"	CrV					
			HT1S601	PH1	37 mm	50	400
			HT1S602	PH2	37 mm	50	400
			HT1S603	PH3	37 mm	50	400

DE PZ Stiftschlüssel EN PH Impact bit socket FR Clef mâle PZ ES Llave de vaso con punta PZ HR Držač bitova PZ HU PZ pneumatikus bitfej készlet RO Biti de impact PZ BG Бит вложка PZ

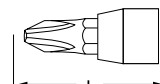

	1/4"	CrV					
			HT1S606	PZ1	37 mm	50	400
			HT1S607	PZ2	37 mm	50	400
			HT1S608	PZ3	37 mm	50	400

DE Bit-Stecknüsse Hex EN Hex bit socket FR Embout de tournevis Hex ES Llave de vaso con punta hexagonal HR Držač bitova hex HU Hex bitfej kulcsok RO Biti hex BG Бит вложка HEX

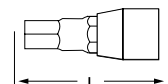

	1/4"	CrV	S2					
				HT1S623	Hex 3 mm	37 mm	50	500
				HT1S624	Hex 4 mm	37 mm	50	500
				HT1S625	Hex 5 mm	37 mm	50	500
				HT1S626	Hex 6 mm	37 mm	50	500
				HT1S627	Hex 7 mm	37 mm	50	500
				HT1S628	Hex 8 mm	37 mm	50	500

DE Torx-Stiftschlüssel EN Torx bit socket FR Clef mâle ES Llave de vaso con punta HR Držač bitova torx HU Torx bitfej dugókulcs RO Biti Torx BG Бит вложка torx

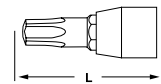

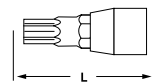

	1/4"	CrV	S2					
				HT1S640	T8	37 mm	50	500
				HT1S642	T10	37 mm	50	500
				HT1S643	T15	37 mm	50	500
				HT1S644	T20	37 mm	50	500
				HT1S645	T25	37 mm	50	500
				HT1S646	T27	37 mm	50	600
				HT1S647	T30	37 mm	50	600
				HT1S648	T40	37 mm	50	600
				HT1S649	T45	37 mm	50	600

DE Bit-Stecknüsse Tamper-torx EN Torx security socket bit FR Embout de tournevis torx ES Llave de vaso con punta torx HR Držač bitova Tamper torx HU Tamper Torx bitfej dugókulcs RO Biti Tamper torx BG Бит вложка torx security

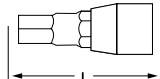

	1/4"	CrV	S2					
				HT1S670	TT6	37 mm	50	300
				HT1S671	TT7	37 mm	50	300
				HT1S672	TT8	37 mm	50	500
				HT1S673	TT9	37 mm	50	300
				HT1S674	TT10	37 mm	50	500
				HT1S675	TT15	37 mm	50	500
				HT1S676	TT20	37 mm	50	400
				HT1S677	TT25	37 mm	50	400
				HT1S678	TT27	37 mm	50	500
				HT1S679	TT30	37 mm	50	400
				HT1S680	TT40	37 mm	50	500

DE Sechskant-Stiftschlüssel EN Hex bit socket FR Clef mâle hex ES Llave de vaso con punta hex HR Držač bitova hex HU Hex bitfej dugókulcs RO Biti Hex BG Бит вложка HEX







Folder	Ø	L	Box	Box
HT1S724	H4	55 mm	50	500
HT1S725	H5	55 mm	50	500
HT1S726	H6	55 mm	50	500
HT1S727	H7	55 mm	50	500
HT1S728	H8	55 mm	50	500
HT1S729	H10	55 mm	50	600
HT1S730	H12	55 mm	50	600
HT1S731	H14	55 mm	50	600
HT1S732	H17	55 mm	50	600

HEX 1/2" CrV S2

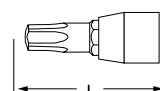
HRC 58-60 DIN 3120

DE Torx-Stiftschlüssel EN Torx bit socket FR Clef mâle torx ES Llave de vaso con punta torx HR Držač bitova torx HU Torx bitfej dugókulcs RO Biti torx BG Бит вложка torx







Folder	Ø	L	Box	Box
HT1S746	T20	55 mm	20	240
HT1S747	T25	55 mm	20	240
HT1S748	T27	55 mm	20	240
HT1S749	T30	55 mm	20	240
HT1S750	T40	55 mm	20	240
HT1S751	T45	55 mm	20	240
HT1S752	T50	55 mm	20	240
HT1S753	T55	55 mm	20	240
HT1S754	T60	55 mm	20	160
HT1S755	T70	55 mm	20	160

TORX 1/2" CrV S2

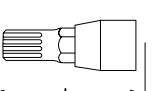
HRC 58-60 DIN 3120

DE Spline-Stiftschlüssel EN Spline bit socket FR Clef mâle spline ES Llave de vaso con punta spline HR Držač bitova spline HU Spline bitfej dugókulcs RO Biti spline BG Бит вложка spline







Folder	Ø	L	Box	Box
HT1S785	M5	55 mm	20	240
HT1S786	M6	55 mm	20	240
HT1S788	M8	55 mm	20	240
HT1S790	M10	55 mm	20	240
HT1S792	M12	55 mm	20	240
HT1S794	M14	55 mm	20	240
HT1S796	M16	55 mm	20	240
HT1S797	M17	55 mm	20	240

SPLINE 1/2" CrV S2

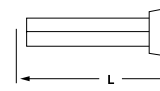
HRC 58-60 DIN 3120

DE Sechskant-Stiftschlüssel EN Hex bit socket FR Clef mâle hex ES Llave de vaso con punta hex HR Držač bitova hex HU Hex bitfej dugókulcs RO Biti hex BG Бит вложка hex







Folder	Ø	L	Box	Box
HT1S524	H4	100 mm	20	120
HT1S525	H5	100 mm	20	120
HT1S526	H6	100 mm	20	120
HT1S527	H7	100 mm	20	120
HT1S528	H8	100 mm	20	120
HT1S529	H10	100 mm	20	120
HT1S530	H12	100 mm	20	120
HT1S531	H14	100 mm	20	120
HT1S532	H17	100 mm	16	64

HEX 1/2" CrV S2

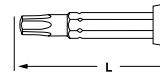
HRC 58-60 DIN 3120

DE Torx-Stiftschlüssel EN Torx bit socket FR Clef mâle torx ES Llave de vaso con punta torx HR Držač bitova torx HU Torx bitfej dugókulcs RO Biti torx BG Бит вложка torx







Folder	Ø	L	Box	Box
HT1S546	T20	100 mm	20	120
HT1S547	T25	100 mm	20	120
HT1S548	T27	100 mm	20	120
HT1S549	T30	100 mm	20	120
HT1S550	T40	100 mm	20	120
HT1S551	T45	100 mm	20	120
HT1S552	T50	100 mm	20	120
HT1S553	T55	100 mm	20	120
HT1S554	T60	100 mm	20	120
HT1S555	T70	100 mm	20	120

TORX 1/2" CrV S2

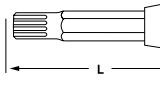
HRC 58-60 DIN 3120

DE Spline-Stiftschlüssel EN Spline bit socket FR Clef mâle spline ES Llave de vaso con punta spline HR Držač bitova spline HU Spline bitfej dugókulcs RO Biti Spline BG Бит вложка spline

Folder	Ø	L	Box	Box
HT1S585	M5	100 mm	20	120
HT1S586	M6	100 mm	20	120
HT1S588	M8	100 mm	20	120
HT1S590	M10	100 mm	20	120
HT1S592	M12	100 mm	20	120
HT1S594	M14	100 mm	20	120
HT1S596	M16	100 mm	16	64
HT1S597	M17	100 mm	16	64

SPLINE 1/2" CrV S2

HRC 58-60 DIN 3120

DE Schrauberbit-Satz mit Ratsche EN Screwdriver bits set FR Set d'embouts de tournevis ES Juego de puntas de destornilladores HR Komplet bitova odvijača HU Csavarhúzó bitfej készlet RO Set de biti surubelnita BG Комплект бит вложки с тресотка



- ⊖ 3, 4, 5, 6
- ⊕ PH1, PH2 x 2, PH3
- ⊕ PZ1, PZ2 x 2, PZ3
- H3, H4, H5, H6
- T10, T15, T20, T25, T27, T30, T40
- TT10, TT15, TT20, T25, T27, T30, T40
- Adapter for sockets Ratchet 1/4", 52T

Folder	Ø	L	Box	Box
HT1R460	1/4"	5	50	

x33 1/4" SLIM S2 52T

DE Schrauberbit-Satz EN Screwdriver bits set FR Coffret d'embouts ES Set puntas de atornillar HR Komplet bitova odvijača HU Csavarhúzó bitfej készlet RO Set de biti surubelnita BG Комплект бит вложки



- ⊕ PH0, PH1 x 2, PH2 x 2, PH3
- ⊕ PZ0, PZ1 x 3, PZ2 x 3, PZ3
- SL3, SL4, SL5, SL6, SL7
- T10, T15, T20, T25, T27, T30, T40
- TT10, TT15, TT20, TT25, TT27, TT30, TT40
- H2, H3, H4, H5, H6
- M5, M6, M8
- Tri Wing: 1, 2, 3
- Square: S0, S1, S2, S3
- Service: 4, 6, 8

Folder	Ø	L	Box	Box
HT1R461	1/4"	5	50	

x50 1/4" S2

DE Schrauberbit-Satz EN Screwdriver bits set FR Coffret d'embouts ES Set puntas de atornillar HR Komplet bitova odvijača HU Csavarhúzó bitfej készlet RO Set de biti surubelnita BG Комплект бит вложки



x24 PRECISION HOLDER CrV HRC 51-54 1x ADAPTER

HT1S273	25 mm	12	96

DE Bohrfutter-Adapter für Nüsse EN Socket bit adapters FR Adaptateurs de douille ES Adaptador para llaves de vaso HR Ručka za nasadne ključeve HU Dugókulcs markolat RO Maner pentru biti tubulari BG Адаптор за вложки, бормашина



1/4" 1/4" 3/8" 1/2" 65 mm 75 mm CrV

HT1S445	1/4"	1/4"	65 mm	10	100
	1/4"	3/8"	65 mm		
	1/4"	1/2"	75 mm		

DE Adapter für Nüsse EN Socket bit adapters FR Adaptateurs de douille ES Adaptador para llaves de vaso HR Držac za nasadne ključeve HU Bithegy-tartó RO Adaptor pentru biți BG Адаптор за вложки



1/2" DRIVE END 1/4" CrV BALL-END ALU GRIP 360°

HT1S446	100 mm	10	100

DE Steckschlüsseleinsatz magnetisch EN Magnetic sockets FR Douilles magnétiques ES Llave de vaso imantada HR Magnetski nasadni ključ HU Mágneses dugókulcs RO Soclu magnetic BG Магнитна вложка



1/4" 48 mm x2 CrV MAGNETIC

HT1S457	8 mm	10	100
HT1S458	10 mm	10	100
HT1S459	12 mm	10	100
HT1S460	13 mm	10	100

DE Schraubendreher-Bit torx EN Torx screwdriver bit FR Embout torx ES Punta de atornillar torx HR Bit odvijača torx HU Torx csavarhúzó bitfej RO Biti surubelnita torx BG Бит крайник torx

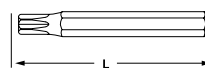

TORX S2 HRC 58-60

HT1S846	T20	75 mm	50	250
HT1S847	T25	75 mm	50	250
HT1S848	T27	75 mm	50	250
HT1S849	T30	75 mm	50	250
HT1S850	T40	75 mm	50	250
HT1S851	T45	75 mm	50	250
HT1S852	T50	75 mm	50	250
HT1S853	T55	75 mm	50	250

DE Schraubendreher-Bit spline EN Spline screwdriver bit FR Embout spline ES Punta de atornillar spline HR Bit odvijača spline HU Spline csavarhúzó bit RO Biti surubelnita spline BG Бит крайник spline

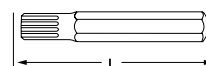

SPLINE S2 HRC 58-60

HT1S885	M5	75 mm	50	250
HT1S886	M6	75 mm	50	250
HT1S888	M8	75 mm	50	250
HT1S890	M10	75 mm	50	250

DE Schraubenzieherspitzen im Set EN Screwdriver bits set FR Coffret d'embouts ES Set de puntas de atornillar, caja de metal HR Garnitura bitova odvijača HU Szerzőkészlet RO Trusa de scule BG Комплект битове



3/8":

- 30 mm: T20, T25, T30, T40, T45, T50, T55
- 75 mm: T20, T25, T30, T40, T45, T50, T55
- 30 mm: M5, M6, M8, M10, M12
- 75 mm: M5, M6, M8, M10, M12
- 30 mm: H4, H5, H6, H7, H8, H10, H12
- 75 mm: H4, H5, H6, H7, H8, H10, H12
- 10 mm, 3/8"
- 10 mm, 1/2"

x40 S2 3/8" 1/2"

TORX SPLINE HEX

HT1S405	3/8", 1/2"	1	10



DE Schraubenzieherspitzen im Set **EN** Screwdriver bits set **FR** Coffret d'embouts **ES** Set de puntas de atornillar, caja de metal **HR** Garnitura bitova odvijača **HU** Szerzőszámkészlet **RO** Trusa de scule **BG** Комплект битове



- 3/8":**
- ⊕ 30 mm: T20, T25, T30, T40, T45, T50, T55
 - ⊕ 75 mm: T20, T25, T30, T40, T45, T50, T55
 - ⊙ 30 mm: M5, M6, M8, M10, M12
 - ⊙ 75 mm: M5, M6, M8, M10, M12
 - ⊙ 30 mm: H4, H5, H6, H7, H8, H10, H12
 - ⊙ 75 mm: H4, H5, H6, H7, H8, H10, H12
 - ⊙ 10 mm, 3/8"
 - ⊙ 10 mm, 1/2"



x40	CrV	3/8" 1/2"
TORX	SPLINE	HEX

HT1S404	3/8", 1/2"	1	10

DE Sechskantschlüsselsatz kurz **EN** Hex key set **FR** Jeu de clés hexagonales **ES** Juego de llaves Allen **HR** Šesterokutni ključevi **HU** Hex kulcsok **RO** Chei hex **BG** Имбусни ключове къси



- ⊙ 1,5; 2; 2,5; 3; 4; 5; 6; 8; 10

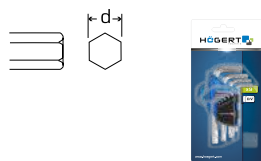

x9	HEX	CrV	DIN ISO 911	SHORT
----	-----	-----	-------------	-------

HT1W802	1,5-10 mm	12	72

DE Sechskantschlüsselsatz lang **EN** Hex key set, long arm **FR** Jeu de clés hexagonales **ES** Juego de llaves Allen **HR** Šesterokutni ključevi **HU** Hex kulcsok **RO** Chei hex **BG** Имбусни ключове удължени

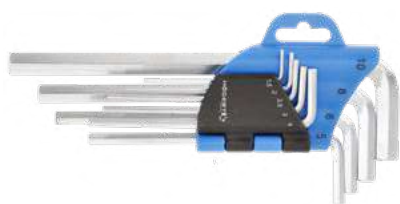

- ⊙ 1,5; 2; 2,5; 3; 4; 5; 6; 8; 10 mm

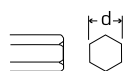

x9	HEX	CrV	LONG	DIN ISO 911
----	-----	-----	------	-------------

HT1W801	1,5-10 mm	12	48

DE Sechskantschlüsselsatz extra lang **EN** Hex key set, extra long arm **FR** Jeu de clés hexagonales **ES** Juego de llaves Allen **HR** Šesterokutni ključevi **HU** Hex kulcsok **RO** Chei hex **BG** Имбусни ключове много дълги



- ⊙ 1,5; 2; 2,5; 3; 4; 5; 6; 8; 10 mm



x9	HEX	CrV	EXTRA LONG	DIN ISO 911
----	-----	-----	------------	-------------

HT1W803	1,5-10 mm	10	40

DE Sechskantschlüsselsatz für präzise Arbeiten **EN** Precision hex key set **FR** Jeu de clés hexagonales de précision **ES** Juego de llaves Allen de precisión **HR** Šesterokutni ključevi, precizni **HU** Precíziós hex kulcskészlet **RO** Set de chei hex de precizie **BG** Имбусни ключове точни

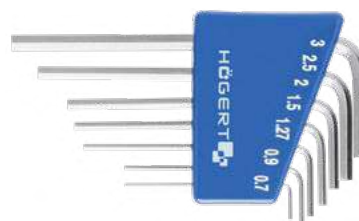

- ⊙ 0,6; 0,9; 1,17; 1,5; 2; 2,5; 3 mm

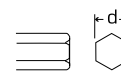

x7	HEX	CrV
----	-----	-----

HT1W800	0,71-3,0 mm	12	144

DE Sechskantschlüsselsatz, lange **EN** Hex key set, long arm **FR** Jeu de clés hexagonales extra-longues **ES** Juego de llaves Allen de brazo largo **HR** Šesterokutni ključevi, dugi, dijagonalni **HU** Hex kulcsok, hosszú, átlós **RO** Chei lungi hex, transversal **BG** Имбусни ключове дълги



- ⊙ 1,5; 2; 2,5; 3; 4; 5; 6; 8; 10 mm



x9	HEX	CrV	EXTRA LONG
----	-----	-----	------------

HT1W807	1,5-10 mm	6	24

DE Sechskantschlüsselsatz mit Kugelkopf **EN** Pall-end hex key set, long arm **FR** Jeu de clés hexagonales à tête sphérique **ES** Juego de llaves Allen con punta bola, acero **HR** Šesterokutni ključevi **HU** Hex kulcsok **RO** Chei hex **BG** Имбусни ключове със сферична глава, дълги



- ⊙ 1,5; 2; 2,5; 3; 4; 5; 6; 8; 10 mm

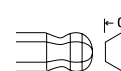

x9	HEX	CrV	LONG
----	-----	-----	------

HT1W804	1,5-10 mm	12	48

DE Sechskantschlüssel, lange EN Pall-end hex key set, extra long arm FR Jeu de clés hexagonales extra-longues ES Juego de llaves Allen de brazo largo HR Šesterokutni ključevi HU Hex kulcsok RO Chei hex BG Имбусни удължени ключове със сферична глава, много дълги



○
1,5; 2; 2,5; 3; 4;
5; 6; 8; 10 mm

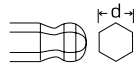

x9	HEX	CrV	EXTRA LONG
----	-----	-----	------------

HT1W808	1,5-10 mm	10	40

DE Torx-Schlüsselsatz EN Torx key set, long arm FR Jeu de clés torx ES Juego de llaves torx HR Torx ključevi HU Torx kulcsok RO Chei torx BG Имбусни ключове torx дълги



⊙
T10, T15, T20, T25, T27,
T30, T40, T45, T50

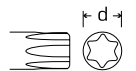

x9	TORX	CrV	LONG
----	------	-----	------

HT1W814	T10-T50	12	48

DE Torx-Schlüsselsatz, lang EN Torx key set, extra long arm FR Jeu de clés Torx colorés ES Juego de llaves Torx de brazo largo HR Torx ključevi HU Torx kulcsok RO Chei torx BG Имбусни ключове torx много дълги



⊙
T10, T15, T20, T25, T27,
T30, T40, T45, T50

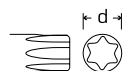

x9	TORX	CrV	EXTRA LONG
----	------	-----	------------

HT1W818	T10-T50	10	40

DE Torx security-Schlüsselsatz EN Torx security key set, long arm FR Jeu de clés torx security ES Juego de llaves torx security HR Torx security ključevi HU Torx security kulcsok RO Chei torx security BG Имбусни ключове torx security, дълги



⊙
TT10, TT15, TT20, TT25,
TT27, TT30, TT40, TT45,
TT50

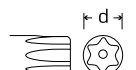

x9	TAMPER TORX	CrV	LONG
----	-------------	-----	------

HT1W809	TT10-TT50	6	48

DE Torx security-Schlüsselsatz EN Tamper torx key set, extra long arm FR Jeu de clés torx security ES Juego de llaves torx security HR Torx security ključevi HU Torx security kulcsok RO Chei torx security BG Имбусни ключове torx security, много дълги



⊙
TT10, TT15, TT20, TT25,
TT27, TT30, TT40, TT45,
TT50

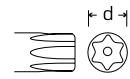

x9	TAMPER TORX	CrV	EXTRA LONG
----	-------------	-----	------------

HT1W810	TT10-TT50	6	340

DE Sechskantschlüsselsatz kurz EN Hex key set FR Jeu de clés hexagonales ES Juego de llaves Allen HR Šesterokutni ključevi HU Hex kulcsok RO Chei hex BG Имбусни ключове къси



○
1,5; 2; 2,5; 3; 4; 5; 6; 8; 10 mm

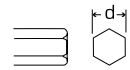

x9	HEX	S2	SHORT
----	-----	----	-------

HT1W820	1,5-10 mm	6	520

DE Sechskantschlüsselsatz lang EN Hex key set, long arm FR Jeu de clés hexagonales ES Juego de llaves Allen HR Šesterokutni ključevi HU Hex kulcsok RO Chei hex BG Имбусни ключове удължени



○
1,5; 2; 2,5; 3; 4; 5; 6;
8; 10 mm

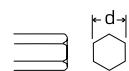

x9	HEX	S2	LONG
----	-----	----	------

HT1W821	1,5-10 mm	6	500

DE Sechskantschlüsselsatz extra lang EN Hex key set, extra long arm FR Jeu de clés hexagonales ES Juego de llaves Allen HR Šesterokutni ključevi HU Hex kulcsok RO Chei hex BG Имбусни ключове много дълги



○
1,5; 2; 2,5; 3; 4; 5; 6;
8; 10 mm

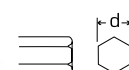

x9	HEX	S2	EXTRA LONG
----	-----	----	------------

HT1W822	1,5-10 mm	6	340

DE Sechskantschlüssel mit Kugel, lang EN Pall-end hex key set, long arm FR Clés hexagonales à bille, longues ES Llaves hexagonales con bola, largas HR Ključevi šesterokutni s kuglicom, dugi HU Hatszögletű golyós kulcs, hosszú RO Chei hexagonale cu bilă, lungi BG Имбусни удължени ключове със сферична глава, дълги



○
1,5; 2; 2,5; 3; 4; 5; 6;
8; 10 mm

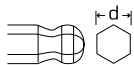

x9	HEX	S2	LONG				
				HT1W825	1,5-10 mm	5	600

DE Sechskantschlüssel mit Kugel, extra lang EN Pall-end hex key set, extra long arm FR Clés hexagonales à boule, ultra longues ES Llaves hexagonales con bola, extra largas HR Ključevi šesterokutni s kuglicom, ekstra dugi HU Hatszögletű kulcsok golyós, extra hosszú RO Chei hexagonale cu bilă, foarte lungi BG Имбусни удължени ключове със сферична глава, много дълги



○
1,5; 2; 2,5; 3; 4; 5; 6;
8; 10 mm



x9	HEX	S2	EXTRA LONG				
				HT1W826	1,5-10 mm	6	340

DE Sicherheits-Torx-Schlüssel, lang EN Tamper torx key set FR Clés torx de sécurité, longues ES Llaves torx de seguridad, largas HR Torx sigurnosni ključevi, dugi HU Torx security kulcs, hosszú RO Chei torx security, lungi BG Имбусни ключове torx security, дълги



⊕
TT10, TT15, TT20,
TT25, TT27, TT30,
TT40, TT45, TT50

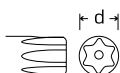

x9	TAMPER TORX	S2	LONG				
				HT1W830	TT10-TT50	6	500

DE Sicherheits-Torx-Schlüssel, extra lang EN Tamper torx key set, long arm FR Clés torx de sécurité, ultra longues ES Llaves torx de seguridad, extra largas HR Torx sigurnosni ključevi, ekstra dugi HU Torx security kulcs, extra hosszú RO Chei torx security, extra lungi BG Имбусни ключове torx security, много дълги



⊕
TT10, TT15, TT20,
TT25, TT27, TT30,
TT40, TT45, TT50

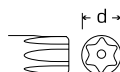

x9	TAMPER TORX	S2	EXTRA LONG				
				HT1W831	TT10-TT50	6	340

DE Torx-Schlüsselsatz, lang EN Torx key set, long arm FR Jeu de clés Torx ES Juego de llaves torx HR Torx ključevi HU Torx kulcsok RO Chei torx BG Имбусни ключове torx дълги



⊕
T10, T15, T20, T25, T27,
T30, T40, T45, T50

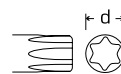

x9	TORX	S2	LONG				
				HT1W816	T10-T50	10	40

DE Sechskantschlüsselsatz, lang EN Hex key set FR Jeu de clés hexagonales colorées à tête sphérique ES Juego de llaves Allen de brazo largo HR Šesterokutni ključevi, kodirani bojom HU Hex kulcsok, színkódos RO Chei hex, cu cod de culoare BG Имбусни ключове



○
1,5; 2; 2,5; 3; 4;
5; 6; 8; 10 mm

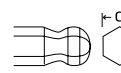

x9	HEX	LONG					
		S2	DIN ISO 911	HT1W806	1,5-10 mm	6	48

DE Torx-Schlüsselsatz, lang, Multicolour EN Torx key set FR Jeu de clés torx colorés ES Juego de llaves Torx de brazo largo HR Torx ključevi, kodirani bojom HU Torx kulcsok, színkódos RO Chei torx, cu cod de culoare BG Имбусни ключове torx



⊕
TT10, TT15, TT20, TT25,
TT27, TT30, TT40, TT45, TT50

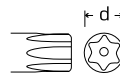

x9	TAMPER TORX	S2	LONG				
				HT1W817	T10-T50	6	48

DE Sechskantschlüssel mit Kugel, lang EN Pall-end hex key set, long arm FR Clés hexagonales à bille, longues ES Llaves hexagonales con bola, largas HR Ključevi šesterokutni s kuglicom, dugi HU Hatszögletű golyós kulcs, hosszú RO Chei hexagonale cu bilă, lungi BG Имбусни удължени ключове със сферична глава, дълги

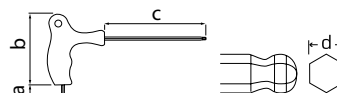
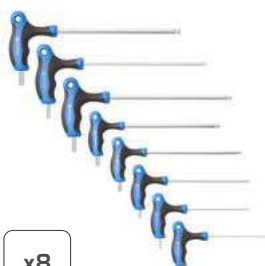

x8	HEX	S2	LONG				
				HT1W880		40	400

	a (mm)	b (mm)	c (mm)	d (mm)		
HT1W880	13,5	56	75	2,5	40	400
	13,5	56	75	3		
	13,5	75	100	4		
	17,5	75,6	150	5		
	17,5	75,6	150	6		
	17,5	75,6	150	7		
	21,5	97,6	200	8		
	21,5	97,6	200	10		

DE Sechskantschlüssel mit Kugel, lang EN Pall-end hex key set, long arm FR Clés hexagonales à bille, longues ES Llaves hexagonales con bola, largas HR Ključevi šestokutni s kuglicom, dugi HU Hatszögletű golyós kulcs, hosszú RO Chei hexagonale cu bilă, lungi BG Имбусни удължени ключове със сферична глава, дълги

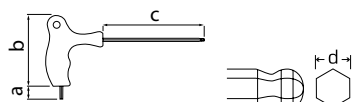

	a (mm)	b (mm)	c (mm)	d (mm)		
HT1W852	13,5	56	75	2,5	40	400
HT1W853	13,5	56	75	3	40	400
HT1W854	13,5	75	100	4	40	400
HT1W855	17,5	75,6	150	5	20	200
HT1W856	17,5	75,6	150	6	20	200
HT1W857	17,5	75,6	150	7	10	100
HT1W858	21,5	97,6	200	8	10	80
HT1W859	21,5	97,6	200	10	10	40

HEX S2 LONG

DE Sicherheits-Torx-Schlüssel, lang EN Tamper torx key set FR Clés torx de sécurité, longues ES Llaves torx de seguridad, largas HR Torx sigurnosni ključevi, dugi HU Torx security kulcs, hosszú RO Chei torx security, lungi BG Имбусни ключове torx security, дълги

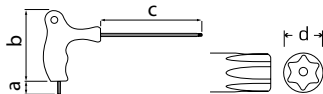

	a (mm)	b (mm)	c (mm)	d (mm)		
HT1W867	13,5	56	75	T8	40	400
HT1W868	13,5	56	75	T9	40	400
HT1W869	13,5	56	75	T10	40	400
HT1W870	13,5	56	75	T15	40	400
HT1W871	13,5	56	100	T20	40	400
HT1W872	13,5	56	100	T25	40	400
HT1W873	17,5	75,6	150	T27	20	200
HT1W874	17,5	75,6	150	T30	20	200
HT1W875	17,5	75,6	150	T40	20	200
HT1W876	21,5	97,6	200	T45	10	80
HT1W877	21,5	97,6	200	T50	10	80

TAMPER TORX S2 LONG

DE Sicherheits-Torx-Schlüssel, lang EN Tamper torx key set FR Clés torx de sécurité, longues ES Llaves torx de seguridad, largas HR Torx sigurnosni ključevi, dugi HU Torx security kulcs, hosszú RO Chei torx security, lungi BG Имбусни ключове torx security, дълги

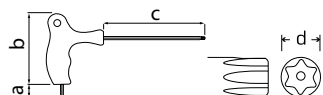
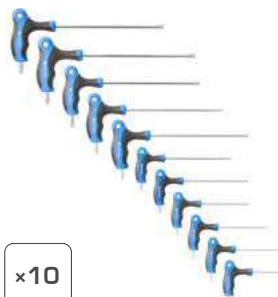

	a (mm)	b (mm)	c (mm)	d (mm)		
HT1W881	13,5	56	75	T8	6	12
	13,5	56	75	T9		
	13,5	56	75	T10		
	13,5	56	75	T15		
	13,5	56	100	T20		
	13,5	56	100	T25		
	17,5	75,6	150	T27		
	17,5	75,6	150	T30		
	17,5	75,6	150	T40		
	21,5	97,6	200	T45		

x10 TAMPER TORX LONG S2

DE Präzisions-Schraubendreher-Satz EN Precision screwdriver set FR Coffret de tournevis de précision ES Caja destornilladores de precisión HR Set odvijača, precizni HU Precision Screwdriver Set RO Set de surubelnite de precizie BG Комплект прецизни отвертки



$\ominus 0.5 \times 3.0 \times 25$ mm
 $\ominus 0.4 \times 2.5 \times 25$ mm
 $\ominus 0.4 \times 2.0 \times 25$ mm
 $\ominus 0.3 \times 1.6 \times 25$ mm
 $\oplus 0 \times 3.0 \times 25$ mm
 $\oplus 00 \times 2.5 \times 25$ mm

x6 CrV MAGNETIC ERGO GRIP

HT1S272		12	72

DE Präzisions-Schraubendreher-Satz EN Precision screwdriver set FR Coffret de tournevis de précision ES Caja destornilladores de precisión HR Komplet preciznih odvijača HU Precision screwdriver set RO Set de surubelnite de precizie BG Комплект прецизни отвертки



$\ominus 1,5 \times 50$ mm
 $\ominus 2 \times 50$ mm
 $\oplus PH00 - 50$ mm
 $\oplus PH0 - 50$ mm
 $\bullet T5 - 50$ mm
 $\bullet T6 - 50$ mm
 $\bullet T7 - 50$ mm



x7 MAGNETIC ERGO GRIP

HT1S270		6	36

DE Präzisions-Schraubendreher-Satz EN Precision screwdriver set FR Coffret de tournevis de précision ES Caja destornilladores de precisión HR Komplet preciznih odvijača za pametne telefone i prenosna računala HU Precíziós csavarhúzó készlet okostelefonokhoz és laptopokhoz RO Set de surubelnite de precizie, pentru smart-phone-uri si laptopuri BG Комплект прецизни отвертки



$\ominus 1,2$ mm
 $\ominus 2,0$ mm
 $\bullet 0,8 / 2,0$ mm
 $\oplus PH00 / PH000$
 $\bullet T4 / T5 / T6 / T7 / T8 / T10$

x17 CrV MAGNETIC ERGO GRIP

HT1S271		6	24

DE Schraubendreher EN Screwdriver set FR Jeu de Tournevis ES Juego de destornilladores HR Komplet odvijača HU Csavarhúzó készlet RO Set de surubelnite BG Комплект отвертки



$\ominus 3 \times 75$ mm
 $\ominus 5 \times 100$ mm
 $\oplus PH1 - 75$ mm
 $\oplus PH2 - 100$ mm



x4 S2 MAGNETIC ERGO GRIP

HT1S094		6	24

DE Schraubendreher eingestellt EN Screwdriver set FR Jeu de Tournevis ES Juego de destornilladores HR Komplet odvijača HU Csavarhúzó készlet RO Set de surubelnite BG Комплект отвертки



$\ominus 6 \times 100$ mm
 $\ominus 5 \times 75$ mm
 $\ominus 3 \times 75$ mm
 $\oplus PH2 \times 100$ mm
 $\oplus PH1 \times 75$
 $\oplus PH0 \times 75$



x6 S2 MAGNETIC ERGO GRIP

HT1S095		6	36

DE Schraubendreher eingestellt EN Screwdrivers set FR Jeu de Tournevis ES Juego de destornilladores HR Set odvijača HU Csavarhúzó készlet RO Set de surubelnite BG Комплект отвертки



- ⊖ 6 x 125 mm, 5 x 100 mm, 3 x 75 mm
- ⊕ PH2 x 125 mm, PH2 x 100 mm, PH1 x 100 mm, PH0 x 75 mm
- Precision screwdrivers:
- ⊖ 2.0 x 50 mm, 2.5 x 50 mm
- T6 x 50 mm, T8 x 50 mm
- ⊕ PH00 x 50 mm, PH000 x 50 mm
- 1/4" socket adapter
- Magnetizer
- Magnetic handle
- 1/4" bit handle
- Off-set key:
- PH2 x SL 6 mm, PH1 x SL 5 mm
- 1/4" screwdriver bits:
- ⊖ SL 3 mm, 2 x 4 mm, 2 x 5 mm, 2 x 6 mm
- ⊕ PH0, 2 x PH1, 2 x PH2, 2 x PH3
- ⊕ PZ0, 2 x PZ1, 2 x PZ2, PZ3
- T10, T15, T20, T25, T27, T30, T35
- H3, H4, H5, H6
- S0, S1, S2, S3
- 1/4" sockets:
- 4 mm, 5 mm, 6 mm, 7 mm, 8 mm, 9 mm, 10 mm, 11 mm, 12 mm

x64	S2	CrV	MAGNETIC	ERGO GRIP
-----	----	-----	----------	-----------

HT1S105	6	12

DE Schraubendreher eingestellt EN Screwdrivers set FR Jeu de Tournevis ES Juego de destornilladores HR Set odvijača i bitova HU Csavarhúzó és bitfej készlet RO Set de surubelnite si biti BG Комплект отвертки



- 16 screwdrivers
- ⊖ Flat screwdrivers: 3 x 75 mm, 5 x 75 mm, 5 x 100 mm, 6 x 100 mm, 6 x 150 mm, 8 x 150 mm
- ⊕ Cross screwdrivers: PH0 x 75 mm, PH1 x 75 mm, PH1 x 100 mm, PH2 x 100 mm, PH2 x 150 mm
- Torx screwdrivers: T10 x 75 mm, T15 x 75 mm, T20 x 75 mm
- ⊙ Square screwdrivers: S1 x 75 mm, S2 x 100 mm
- Screwdriver bits on socket 1" (48 pieces)
- 3 mm, 3 mm, 4 mm, 4 mm, 5 mm, 5 mm, 6 mm, 6 mm
- ⊕ PH0, PH0, PH1, PH1, PH2, PH2, PH3, PH3
- T10, T10, T15, T15, T20, T20, T25, T25, T25, T27, T27, T30, T30
- H3, H3, H4, H4, H5, H5, H5, H6, H6, H6
- S0, S0, S1, S1, S2, S2, S3, S3
- Hexagonal screwdrivers (16 pieces)
- 1.5 mm, 2.0 mm, 2.5 mm, 3.0 mm, 4.0 mm, 5.0 mm, 5.5 mm, 6.0 mm
- 1/16", 5/64", 3/32", 1/8", 5/32", 3/16", 7/32", 1/4"
- Precision screwdriver bits (20 pieces)
- PH000, PH000, Y000, Y000
- 0.8 mm, 0.8 mm, 1.2 mm, and 1.2 mm
- T4, T4, T5, T5, T6, T6
- 1.0 mm, 1.0 mm, 1.5 mm, 1.5 mm, 2.0 mm, 2.0 mm
- Nut Drivers (6 pieces)
- 6 mm, 7 mm, 8 mm, 9 mm, 10 mm, 11 mm
- Precision screwdrivers (6 pieces)
- 2.0 x 40 mm, 2.5 x 40 mm, 3.0x40 mm, PH00 x 40 mm, PH0 x 40 mm, T10 x 40 mm
- Bit adapter
- Precision bit adapter
- Socket adapter



x114	S2	CrV	MAGNETIC	ERGO GRIP
------	----	-----	----------	-----------

HT1S099	3	6

DE Schraubendreher eingestellt EN Screwdrivers set FR Jeu de Tournevis ES Juego de destornilladores HR Set odvijača HU Csavarhúzó készlet RO Set de surubelnite BG Комплект отвертки



- ⊖ 1 x flat screwdriver for hammering hex with the possibility of using a flat wrench - 6x125 mm;
- ⊕ 1 x cross-head screwdriver PH for hammering hex with the possibility of using a flat wrench - 2x125 mm;
- ⊖ 3 x flat screwdrivers: 6x125, 5x100, 3x75 mm;
- ⊕ 3 x cross-head screwdrivers PH: P2x125, PH1x100, PH0x75 mm;
- 1 x bit holder for screwdriver bits;
- 1 x holder for precision bits;
- 4 x precision screwdrivers: 2.5x50, 3.0x50, PH00x50, PH0x50 mm;
- 29 x precision bits 4x28 mm;
- 49 x screwdriver bits 6.35x25 mm;
- 1 x socket adapter for screws and nuts;
- 7 x sockets for screws and nuts: 2.5, 3, 3.5, 4, 4.5, 5, 5.5 mm;
- 9 x 1/4" sockets: 5, 6, 7, 8, 9, 10, 11, 12, 13 mm;
- 1 x magnetic holder 60 mm;
- 1 x magnetic, precision holder 60 mm;
- 1 x tweezers.



x112	S2 STEEL	CrV
MAGNETIC	ERGO GRIP	MULTIPLE OPTIONS

HT1S102	25 mm	3	6

DE Schraubendreher eingestellt EN Screwdriver set FR Jeu de Tournevis ES Juego de destornilladores HR Komplet odvijača HU Csavarhúzó készlet RO Set de surubelnite BG Комплект отвертки



- ⊖ 6 x 150 mm
- ⊖ 5 x 75 mm
- ⊖ 3 x 75 mm
- ⊖ 6 x 38 mm
- ⊕ PH2 x 150 mm
- ⊕ PH1 x 75
- ⊕ PH0 x 75
- ⊕ PH2 x 38



x8	S2	MAGNETIC	ERGO GRIP
----	----	----------	-----------

HT1S096	6	24

DE Schraubendreher eingestellt EN Screwdriver set FR Jeu de Tournevis ES Juego de destornilladores HR Set odvijača HU Csavarhúzó készlet RO Set de surubelnite BG Комплект отвертки



- ⊖ 6 x 125 mm, 5 x 100 mm, 3 x 75 mm, 6 x 38 mm
- ⊕ PH2 x 125 mm, PH1 x 100 mm, PH0 x 75 mm, PH2 x 38 mm
- ⊖ 2,0 x 40 mm, 2,5 x 40 mm
- ⊕ PH0 x 40 mm, PH00 x 40 mm



x12	S2	CrV	MAGNETIC	ERGO GRIP
-----	----	-----	----------	-----------

HT1S097	6	12

DE Schraubendreher EN Screwdriver set FR Jeu de Tournevis ES Juego de destornilladores HR Komplet odvijača HU Csavarhúzó készlet RO Set de surubelnite BG Комплект отвертки

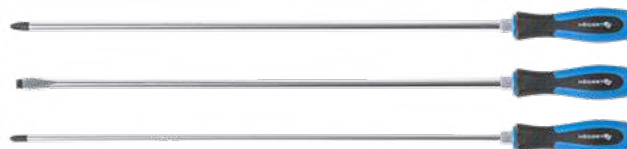

x3	450 mm	⊖ SL	⊕ PH2
⊕ PH3	CrV	ERGO	

HT1S084	4	12

DE Schraubendreher EN Screwdriver FR Tournevis ES Destornillador HR Odvijač HU Csavarhúzó RO Șurubelniță BG Отвертка



450 mm	⊕ PH2	CrV	ERGO
--------	-------	-----	------

HT1S083	6	48

DE Schraubendreher EN Screwdriver FR Tournevis ES Destornillador HR Odvijač
HU Csavarhúzó RO Șurubelniță BG Отвертка



450 mm PH3 CrV ERGO

HT1S082	6	48

DE Schraubendreher EN Screwdriver FR Tournevis ES Destornillador HR Odvijač
HU Csavarhúzó RO Șurubelniță BG Отвертка



450 mm SL CrV ERGO

HT1S081	6	48

DE Schraubendreher EN Screwdriver set FR Jeu de Tournevis ES Juego de destornilladores
HR Komplet odvijaca HU Csavarhúzó készlet RO Set de șurubelnițe BG Комплект отвертки

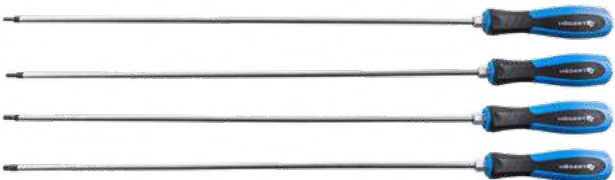

450 mm TORX CrV ERGO MAGNETIC

HT1S079	T15, T20, T25, T30	4	12

DE Schraubendreher EN Screwdriver FR Tournevis ES Destornillador HR Odvijač
HU Csavarhúzó RO Șurubelniță BG Отвертка



450 mm TORX CrV ERGO MAGNETIC

HT1S085	T15	6	48

DE Schraubendreher EN Screwdriver FR Tournevis ES Destornillador HR Odvijač
HU Csavarhúzó RO Șurubelniță BG Отвертка



NEW

450 mm TORX CrV ERGO MAGNETIC

HT1S086	T20	6	48

DE Schraubendreher EN Screwdriver FR Tournevis ES Destornillador HR Odvijač
HU Csavarhúzó RO Șurubelniță BG Отвертка



NEW

450 mm TORX CrV ERGO MAGNETIC

HT1S087	T25	6	48

DE Schraubendreher EN Screwdriver set FR Jeu de Tournevis ES Juego de destornilladores
HR Komplet odvijaca HU Csavarhúzó készlet RO Set de șurubelnițe BG Комплект отвертки



NEW

450 mm TORX CrV ERGO MAGNETIC

HT1S088	T30	6	48

DE Schraubendreher EN Screwdriver set FR Jeu de Tournevis ES Juego de destornilladores
HR Komplet odvijaca HU Csavarhúzó készlet RO Set de șurubelnițe BG Комплект отвертки



- ⌀ 6 x 38 mm, 5 x 75 mm, 6 x 100 mm, 8 x 150 mm
- ⊕ PH1 x 75 mm, PH2 x 38 mm, PH2 x 100 mm, PH3 x 150 mm
- ⊖ 2,5 x 40 mm, 3,0 x 40 mm
- ⊕ PH00 x 40 mm, PH0 x 40 mm
- T5 x 40 mm, T6 x 40 mm, T7 x 40 mm, T8 x 40 mm, T9 x 40 mm, T10 x 40 mm



×18 S2 ERGO GRIP MAGNETIC

HT1S098	6	24

DE Schraubendreher eingestellt EN Screwdriver with accessories FR Jeu de Tournevis ES Juego de destornilladores HR Set odvijača HU Csavarhúzó készlet RO Set de surubelnite BG Комплект отвертки с аксесоари



- ⊖ SL 3 mm, 4 mm, 5 mm, 6 mm
- ⊕ PH0, PH1, PH2, PH3
- ⊗ PZ0, PZ1, PZ2, PZ3
- ⦿ T10, T15, T20, T25
- ⦿ TT10, TT15, TT20, TT25
- H3, H4, H5, H6
- 1/4" socket adapter
- 1/4" sockets:
- 4 mm, 5 mm, 6 mm, 7 mm,
- 8 mm, 9 mm

x34	S2	CrV	MAGNETIC	ERGO GRIP			
					HT1S100	6	24

DE Schraubendreher eingestellt EN Screwdriver with accessories FR Jeu de Tournevis ES Juego de destornilladores HR Set odvijača HU Csavarhúzó készlet RO Set de surubelnite BG Комплект отвертки с аксесоари



- ⊖ SL 3 mm, 4 mm, 5 mm,
- 6 mm, 7 mm
- ⊕ PH0, PH1, PH2, PH3
- ⊗ PZ0, PZ1, PZ2, PZ3
- ⦿ T10, T15, T20, T25
- ⦿ TT10, TT15, TT20, TT25
- H3, H4, H5, H6
- 1/4" socket adapter
- 1/4" sockets:
- 4 mm, 5 mm, 6 mm, 7 mm, 8 mm,
- 9 mm, 10 mm, 11 mm, 12 mm

x36	S2	CrV	MAGNETIC	RATCHED HANDLE	ERGO GRIP		
					HT1S101	6	24

DE Schraubendreher Set EN Screwdriver with 1:5 gear and accessories FR Jeu de tournevis ES Juego de destornilladores HR Odvijač s nastavcima HU Csavarhúzó készlet RO Set de surubelnite BG Отвертка с бит държач тресчотна 1:5 с аксесоари



- ⊖ 3 mm, 4 mm, 5 mm, 6 mm
- ⊕ PH0, PH1, PH2, PH3
- ⦿ T10, T15, T20, T25

x13	360° 1:5	S2	MAGNETIC	ERGO GRIP			
					HT1S215	6	36

DE Schraubendreher Set EN Screwdriver with 1:5 gear and accessories FR Jeu de tournevis ES Juego de destornilladores HR Odvijač s nastavcima HU Csavarhúzó készlet RO Set de surubelnite BG Отвертка с бит държач тресчотна 1:5 и чупеца дръжка с аксесоари



- ⊖ 3 mm, 4 mm, 5 mm, 6 mm
- ⊕ PH0, PH1, PH2, PH3
- ⦿ T10, T15, T20, T25

x13	360° 1:5	S2	MAGNETIC	RATCHED HANDLE	ERGO GRIP		
					HT1S216	6	36

DE Bit-Schraubendreher, kurze Ausführung mit Ratsche EN Ratcheting multi-bit screwdriver FR Tournevis multi-embouts à cliquet ES Destornillador multipuntas de carraca HR Odvijač sa zamenljivim bitovima HU Multi-bitfej csavarhúzó RO Surubelnita multi-bit BG Отвертка с тресчотка и битове



- 3 mm, 6 mm
- ⊕ PH1
- ⊕ PH2
- ⊕ PH3
- ⦿ T15
- ⦿ T20
- H4

x9	length 10 cm	S2	MAGNETIC	ERGO GRIP			
					HT1S214	10	100

DE Steckschlüssel-Schraubendreher EN Screwdriver bit holder FR Tournevis porte-embout ES Destornillador Portapuntas HR Ručka za bitove odvijača HU Csavarhúzó bitfej adapter RO Maner biti tip surubelnita BG Отвертка с бит държач



1/4"	CrV	ERGO GRIP							
					HT1S201	1/4"	100 mm	12	144

DE Schlitz-Schraubendreher EN Slotted screwdriver FR Tournevis plat ES Destornillador de punta plana HR Ravni odvijači HU Lapos csavarhúzó RO Surubelnite dreapte BG Отвертка права SL



	⊖	L1	L2		
HT1S001	3	75 mm	163 mm	12	360
HT1S002	3	100 mm	188 mm	12	360
HT1S004	4	100 mm	188 mm	12	360
HT1S008	5	100 mm	198 mm	12	240
HT1S010	6,5	38 mm	104 mm	12	360
HT1S012	6	100 mm	208 mm	12	144
HT1S014	6	150 mm	258 mm	12	144
HT1S015	6,5	200 mm	308 mm	12	144

DE Kreuzschlitzschraubendreher PH EN PH screwdriver FR Tournevis ES Destornillador PH HR Križni odvijači PH HU PH csavarhúzó RO Surubelnite PH BG Отвертка PH



	⊕	L1	L2		
HT1S020	PH0	75 mm	163 mm	12	360
HT1S023	PH1	75 mm	173 mm	12	240
HT1S024	PH1	100 mm	198 mm	12	240
HT1S028	PH2	38 mm	104 mm	12	360
HT1S029	PH2	100 mm	208 mm	12	144
HT1S032	PH2	200 mm	308 mm	12	144

DE Kreuzschlitzschraubendreher PZ EN PZ screwdriver FR Tournevis Pozidriv ES Destornillador Pozidriv PZ HR Križni odvijači PZ HU PZ csavarhúzó RO Surubelnite PZ BG Отвертка PZ

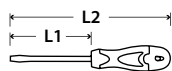

		L1	L2		
HT1S040	PZ0	75 mm	163	12	360
HT1S041	PZ1	100 mm	173	12	240
HT1S042	PZ2	100 mm	208	12	144



DE Schraubendreher torx EN Torx Screwdriver FR Tournevis torx ES Destornillador torx HR Odvijači torx HU Torx csavarhúzó RO Surubelnite torx BG Отвертка torx

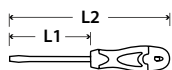

		L1	L2		
HT1S051	T8	75 mm	163 mm	12	240
HT1S053	T10	100 mm	198 mm	12	240
HT1S054	T15	100 mm	198 mm	12	240
HT1S055	T20	100 mm	198 mm	12	240
HT1S056	T25	100 mm	208 mm	12	144
HT1S057	T27	100 mm	208 mm	12	144
HT1S058	T30	100 mm	208 mm	12	144
HT1S059	T40	150 mm	268 mm	6	96



DE Schraubendreher mit Schlagkappe EN Demolition SL screwdriver FR Tournevis plat à frapper ES Destornillador de impacto HR Ravni odvijači za udaranje HU Lapos bontó csavarhúzó RO Surubelnite drepte pentru demolare BG Отвертка SL задвижване

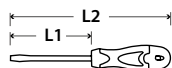

		L1	L2		
HT1S064	5,5	100 mm	200 mm	12	144
HT1S066	6	125 mm	233 mm	12	144
HT1S068	8	150 mm	266 mm	6	96



DE Schraubendreher mit Schlagkappe EN Demolition PH screwdriver FR Tournevis à frapper ES Destornillador de impacto HR Križni odvijač za udaranje HU Bontó csavarhúzó RO Surubelnite pentru demolare BG Отвертка PH задвижване

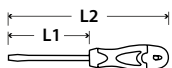

		L1	L2		
HT1S072	PH2	125 mm	233 mm	12	144



DE Magnetisierer-Entmagnetisierer EN Magnetizer-demagnetizer FR Magnétiseur-démagnétiseur ES Magnetizador-desmagnetizador HR Magnetizator-demagnetizator RO Magnetizer-demagnetizator HU Mágnesező-lemágnesező BG Магнетизатор-демагнетизатор



HT1S089	2-in-1	12	144

DE Schlagschrauber EN Impact screwdriver FR Tournevis à percussion ES Destornillador de impacto HR Udarni odvijač HU Útéscsavarhúzó RO Șurubelniță de impact BG Ударна отвертка



- 1/2" - 12.7 mm
- 5/16" - 7.9 mm
- ⊖ 6 x 36 mm
- ⊖ 8 x 36 mm
- ⊖ 8 x 78 mm
- ⊕ PH2 x 36 mm
- ⊕ PH3 x 36 mm
- ⊕ PH3 x 78 mm



HT1S077	1	20	

DE Set offener Ringschlüssel EN Double open-end spanner set FR Ensemble de clés à œil demi-ouvertes ES Juego de llaves de ojo semiabiertas HR Set poluotvorenih okastih ključeva RO Set de chei semideschise HU Félig nyitott csillagkulcs készlet BG Комплект полотворени ключове



- 8 x 10, 11 x 12, 13 x 14, 15 x 17 mm



HT1W730	8-17 mm	1	20

DE Torx Ringschlüssel-Set EN Torx ring spanner set FR Jeu de Clés à œil torx ES Llaves planas cabezal torx HR Komplet okastih ključeva torx HU Kétoldalú torx kulcs RO Maner T glisant cu cheie torx BG Ключове звездогачени torx комплект



- E6 x E8, E10 x E12, E14 x E18, E20 x E24



HT1W590	E6-E24	4	40

DE Ringschlüssel Typ "C" EN C-Type Ring Spanner Set FR Jeu de clés plates courbés en forme «C» ES Juego de llaves de estrella en C HR Set okastih "C" ključeva HU C-típusú csillagkulcs készlet RO Set de chei inelare duble tip C BG Комплект звездогаечни ключове, извити, C - форма



8 x 10, 11 x 13, 14 x 15,
16 x 17, 19 x 22 mm



x5	8-22 mm	CrV
----	------------	-----

HT1W599	8-22 mm	6	24
---------	---------	---	----

DE Tubing Ratschenschlüssel EN Open end flare nut ratchet wrench FR Clé à Cliquet pour Tubes ES Llave de Tubo de Trinquete HR Viličasto-okasti ključ poluotvoreni s čečrtaljškom HU Racsnis kulcs nyitott RO Cheie inelara cu clichet pentru conducte BG Ключ звездогаечен отворен с тресчотка

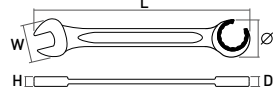

72 T	CrV
------	-----

	L	W	Φ	H	D
HT1R070	8 mm	160	23	28,2	6
HT1R071	10 mm	160	23	28,2	6
HT1R072	13 mm	190	30	34,7	6,5
HT1R073	17 mm	215	36	39,3	7
HT1R074	19 mm	230	40	43,5	8,3

DE Doppelringschlüsselset EN Bi-hexagonal ring spanner set FR Kit de clés a fourche en acier ES Juego de llaves de estrella, acero HR Komplet okastih ključeva HU Hajlított csillagkulcs készlet RO Set de chei inelare duble cotite BG Комплект звездогаечни ключове, извити



6 x 7, 8 x 9, 10 x 11, 12 x 13,
14 x 15, 16 x 17, 18 x 19,
20 x 22 mm



x8	CrV	DIN 838
----	-----	------------

HT1W598	6-22 mm	1	10
---------	---------	---	----

DE Maul-Ring-Schlüsselset EN Combination spanners set FR Kit de Clés Mixtes a cliquet en acier ES Juego de llaves combinadas HR Komplet okasto-viličastih ključeva HU Kombinált villáskulcs készlet RO Set de chei combinate BG Комплект ключове гаечни плоски



6, 8, 10, 11, 12, 13, 14, 15,
17, 19, 22, 24 mm



x12	CrV	15°	AS SYSTEM	DIN 3113
-----	-----	-----	--------------	-------------

HT1W492	6-24 mm	1	10
---------	---------	---	----

DE Maul-Ring-Schlüsselset EN Combination spanners set FR Kit de Clés Mixtes a cliquet en acier ES Juego de llaves combinadas HR Komplet okasto-viličastih ključeva HU Kombinált villáskulcs készlet RO Set de chei combinate BG Комплект ключове гаечни плоски



6, 7, 8, 9, 10, 11, 12, 13, 14, 15,
16, 17, 18, 19, 20, 21, 22, 23, 24,
25, 26, 27, 28, 29, 30, 32 mm



x26	CrV	15°	ASS	DIN 3113
-----	-----	-----	-----	-------------

HT1W496	6-32 mm	1	4
---------	---------	---	---

DE Satz Schlüssel EN Wrenches set FR Jeu de clés ES Juego de llaves HR Set ključeva HU Egy kulcskészlet RO Set de chei BG Комплект ключове

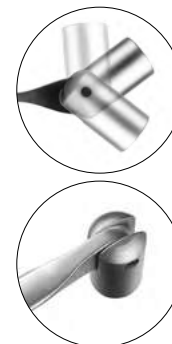

8 x 9 mm
10 x 11 mm
12 x 13 mm
14 x 15 mm
16 x 17 mm
18 x 19 mm

CrV	x6
-----	----

HT1W591	1	10
---------	---	----

DE Satz Schlüssel EN Wrenches set FR Jeu de clés ES Juego de llaves HR Set ključeva HU Egy kulcskészlet RO Set de chei BG Комплект ключове



8, 10, 13, 15, 17, 19 mm

CrV	x6
-----	----

HT1W592	1	10
---------	---	----

DE Satz Schlüssel EN Wrenches set FR Jeu de clés ES Juego de llaves HR Set ključeva HU Egy kulcskészlet RO Set de chei BG Комплект ключове



8, 9, 10, 11, 12, 13, 14, 15,
16, 17, 18, 19, 22, 24 mm

CrV	x14	METRIC IMPERIAL SYSTEM
-----	-----	------------------------------

HT1W497	1	10
---------	---	----



15mm

DE Satz Schraubenschlüssel EN Set of wrench FR Jeu de clés ES Juego de llaves HR Set ključeva HU Torx ütvecsavaros dugókulcs RO Set de chei BG Ударно гнездо „Torx“



- 6, 7, 8, 9, 10, 11, 12, 13, 14, 15, 16, 17, 18, 19, 20, 21, 22, 23, 24, 26, 27, 28, 30, 32 mm
- 6 x 7, 8 x 9, 10 x 11, 12 x 13, 14 x 15, 16 x 17, 18 x 19, 20 x 22 mm
- 8 x 10, 9 x 11, 10 x 12, 13 x 14, 15 x 17, 16 x 18 mm
- 10 x 11, 12 x 13, 14 x 15, 16 x 17, 18 x 19 mm
- E6 x E8, E10 x E12, E14 x E18, E20 x E24 mm

CrV x47



HT1W499	1	2
---------	---	---

DE Maul-Ring-Schlüsselset EN Combination spanners set FR Kit de Clés Mixtes en acier ES Juego de llaves combinadas HR Komplet okasto-viljuškastih ključeva HU Kombinált villáskulcs készlet RO Set de chei combinate BG Комплект ключове гаечни плоски



8, 10, 11, 13, 14, 17, 19 mm

x7 CrV 15° AS SYSTEM DIN 3113

HT1W490	8-19 mm	5	20
---------	---------	---	----

DE Maul-Ringratschenschlüssel Set EN Combination ratchet spanners set FR Kit de Clés Mixtes, en acier ES Juego llaves combinadas con trinquete HR Combination ratchet spanner set HU Racsnis kombinált villáskulcs készlet RO Set de chei combinate cu clichet BG Комплект ключове звездагаечени с тресчотка



10, 12, 13, 14, 15, 17, 19 mm

x7 CrV 15° AS SYSTEM DIN 3113

HT1R397	10-19 mm	5	20
---------	----------	---	----

DE Satz Schlüssel EN Wrenches set FR Jeu de clés ES Juego de llaves HR Set ključeva HU Egy kulcskészlet RO Set de chei BG Комплект ключове



10, 11, 13, 15, 17, 19 mm

CrV x6

HT1W498	1	20
---------	---	----

DE Tubing Ratschenschlüssel EN Open end flare nut ratchet wrench FR Clé à Cliquet pour Tubes ES Llave de Tubo de Trinquete HR Viličasto-okasti ključ poluotvoreni s čegrtaljkom HU Racsnis kulcs nyitott RO Cheie inelara cu clichet pentru conducte BG Ключ звездагаечен отворен с тресчотка

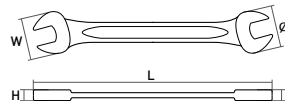

Folder	Icon	L	W	Φ	H	D	Box	Box
HT1W501	6 x 7	134	17,2	15,8	4,9	4,8	25	200
HT1W502	8 x 9	151	24,8	20	5,3	5,2	25	200
HT1W504	10 x 11	158	27	24,8	5,7	5,6	25	200
HT1W506	12 x 13	181	33	31	6,1	6	25	200
HT1W507	13 x 17	189	35	33	6,5	6,4	25	200
HT1W508	14 x 15	197	38,6	33	6,9	6,8	25	200
HT1W509	16 x 17	207	38,6	37	7,2	7,1	25	200
HT1W510	17 x 19	223	42,6	40,8	7,7	7,6	10	100
HT1W511	18 x 19	223	42,6	40,8	7,7	7,6	10	100
HT1W512	19 x 22	239	48,8	44,8	8,3	8,2	10	80
HT1W513	20 x 22	239	48,8	44,8	8,3	8,2	10	80
HT1W514	21 x 23	251	52	48,8	8,8	8,7	10	80
HT1W515	24 x 27	264	56	52	9,4	9,3	10	60
HT1W516	25 x 28	264	56	52	9,4	9,3	10	40
HT1W517	30 x 32	296	69	64,5	11	10,9	10	40

CrV DIN 3110

DE Schrauben-Ring-Schlüssel EN Combination spanner FR Clés Mixtes en acier ES Llave combinada HR Okasto-viljuškasti ključevi HU Kombinált villáskulcsok RO Chei combinate BG Ключ звездагаечен

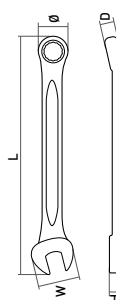

Folder	Icon	L	W	Φ	H	D	Box	Box
HT1W406	6 mm	110	15	10,8	4	4,9	5	300
HT1W407	7 mm	116	17,2	11,8	4,2	5,2	5	300
HT1W408	8 mm	128	19,4	13,5	4,5	5,5	5	300
HT1W409	9 mm	137	21	14,6	4,8	6	5	250
HT1W410	10 mm	148	23,5	16,3	5,2	6,5	5	250
HT1W411	11 mm	157	25,2	17,3	5,5	7	5	250
HT1W412	12 mm	169	27,5	19	5,8	7,5	5	250
HT1W413	13 mm	176	29,4	20	6,1	7,9	5	250
HT1W414	14 mm	186	31,5	22	6,5	8,4	5	150
HT1W415	15 mm	196	33,1	23	6,8	8,8	5	150
HT1W416	16 mm	207	34,8	24,4	7	9,3	5	100
HT1W417	17 mm	219	37	25,6	7,2	9,8	5	100
HT1W418	18 mm	228	38,3	27	7,5	10,3	5	100
HT1W419	19 mm	238	40,8	28,6	7,8	10,8	5	100
HT1W420	20 mm	249	42,6	30	8,1	11,2	5	100
HT1W421	21 mm	260	44,8	31,7	8,4	11,6	5	60
HT1W422	22 mm	270	47,2	33,2	8,7	12,1	5	60
HT1W423	28 mm	258	46,8	33,4	8,3	12,1	10	80
HT1W424	34 mm	289	50,3	35,6	9,3	13	5	60
HT1W425	25 mm	300	52,4	37,2	9,5	13,3	5	60
HT1W426	26 mm	309	54,4	38,6	9,8	13,6	5	60
HT1W427	27 mm	320	5,64	40	10,9	13,9	5	60
HT1W428	28 mm	338	60	42,4	10,5	14,8	5	60
HT1W429	29 mm	330	58,8	42,2	10,2	15,5	10	40
HT1W430	30 mm	352	62,4	44,2	11	15,3	5	60
HT1W432	32 mm	370	66,4	47	11,6	15,7	5	30
HT1W436	36 mm	452	73	51,6	13,2	17,5	5	20
HT1W441	41 mm	480	84	62	15	19	5	20
HT1W446	46 mm	495	94	68	15,5	20	5	20
HT1W450	50 mm	505	103	74	16,5	21	5	20
HT1W455	55 mm	670	109	81	20	29	1	5

CrV 15° AS SYSTEM DIN 3113

DE Schrauben-Ring-Schlüssel mit Ratsche EN Combination ratchet spanner FR Clés Mixtes, en acier ES Llave combinada con trinquete HR Viljuškasto-okasti ključevi s čegrtaljom HU Kombinált racsnis villáskulcsok RO Chei combinate cu clichet BG Ключ звездогаечен с тресчотка

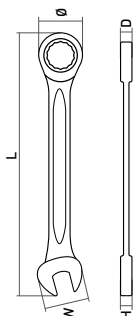

Folder	Icon	L	W	Φ	H	D	Box	Box
HT1R006	6 mm	121	15	14,3	4,5	6,3	5	200
HT1R007	7 mm	130	16,4	16,8	4,8	6,5	5	200
HT1R008	8 mm	140	18	18,3	5,3	7,2	5	200
HT1R009	9 mm	150	20	20	5,7	7,5	5	200
HT1R010	10 mm	160	22	21,5	6	7,8	5	200
HT1R011	11 mm	165	24,5	23,5	6,2	8,4	5	200
HT1R012	12 mm	170	26	25	6,5	8,8	5	200
HT1R013	13 mm	180	28	26,4	6,8	9,1	5	200
HT1R014	14 mm	190	30,8	28	7,2	9,4	5	200
HT1R015	15 mm	200	33	30	7,5	9,8	5	100
HT1R016	16 mm	210	34,5	31,5	7,8	10,2	5	100
HT1R017	17 mm	225	37	33	8,1	10,5	5	100
HT1R018	18 mm	235	39,5	35	8,5	10,8	5	100
HT1R019	19 mm	245	40,8	36,5	8,8	11,2	5	100
HT1R020	20 mm	245	40,8	36,5	8,8	11,2	5	100
HT1R021	21 mm	290	44,8	42,5	9,5	13,5	5	50
HT1R022	22 mm	290	44,8	42,5	9,5	13,5	5	50
HT1R024	24 mm	332	52,8	48,5	10,5	14,5	5	50
HT1R027	27 mm	359	56	53	11,2	15,7	5	40
HT1R030	29 mm	404	62	58	11,7	17	5	20
HT1R032	32 mm	424	65	62	12,3	17,5	5	20

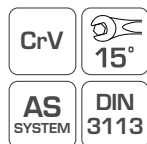

DE Schrauben-Ring-Schlüssel mit Gelenk und Ratsche EN Combination ratchet spanner with flex head FR Clés Mixtes, tête inclinable ES Llave combinada con trinquete articulada HR Ključevi viljuškasto-okasti sa zglobom i čegrtaljom HU Kombinált racsnis villáskulcsok csuklóval RO Chei combinate cu clichet si capat rotativ BG Ключ звездогаечен с тресчотка с подвижна глава

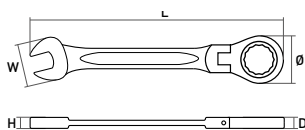

Folder	Icon	L	W	Φ	H	D	Box	Box
HT1R048	8 mm	138	18	18,3	5,3	7,2	5	200
HT1R050	10 mm	158	22	21,5	6	7,8	5	200
HT1R051	11 mm	163	24,5	23,5	6,2	8,4	5	200
HT1R052	12 mm	168	26	25	6,5	8,8	5	200
HT1R053	13 mm	178	28	26,4	6,8	9,1	5	200
HT1R054	14 mm	188	30,8	28	7,2	9,4	5	100
HT1R055	15 mm	196	33	30	7,5	9,8	5	100
HT1R056	16 mm	208	34,5	31,5	7,8	10,2	5	100
HT1R057	17 mm	223	37	33	8,1	10,5	5	100
HT1R058	18 mm	233	39,5	35	8,5	10,8	5	100
HT1R059	19 mm	243	40,8	36,5	8,8	11,2	5	100
HT1R061	21 mm	288	44,8	42,5	9,5	13,5	5	50

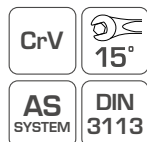

DE Set mit Abziehern und Haken EN Utility pry bar set FR Jeu de tireurs et de crochets ES Juego de tiradores y ganchos HR Skup izvlačača i kuka RO Set de extractoare și cârlige HU Lehúzók és horgok készlete BG Комплект екстрактори и куки

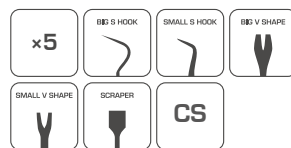

Folder	Box	Box
HT8G397	6	24

DE Abstreiferset EN Scraper set FR Jeu de grattoirs ES Juego de raspadores HR Set strugala HU Kaparó készlet RO Set de racletă BG Комплект инструменти за демонтаж на авто панели



Folder	Box	Box
HT8G394	6	36

DE Haken-Set EN Hook set FR Jeu de crochets ES Juego de manos HR Set udice HU Horgok készlet RO Set de cârlige BG Комплект куки

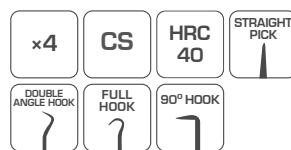

Folder	Box	Box
HT8G395	12	72

DE Set langer Haken EN Extra long pick&hook set FR Ensemble de longs crochets ES Juego de ganchos largos HR Set dugin kuka HU Hosszú kampókészlet RO Set de cârlige lungi BG Комплект дълги куки

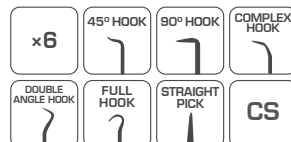

Folder	Box	Box
HT8G398	12	48

DE Kombinationszange EN Combination pliers FR Pince universelle ES Alicates universal HR Uniwerzalna klijesta HU Kombinált fogók RO Cleste combinat BG Клещи комбинирани



CrV HRC 58-62 DIN 5746 180° ERGO GRIP

HT1P006	160 mm	6	60	
HT1P008	180 mm	6	60	
HT1P009	200 mm	6	60	

DE Seitenschneider EN Diagonal side cutters FR Pince coupante ES Alicates de corte diagonal HR Bočna klijesta HU Oldalsípő fogók RO Cleste cu taietura laterala BG Клещи резачки



CrV HRC 58-62 DIN 5749 180° ERGO GRIP

HT1P010	160 mm	6	60	
HT1P012	180 mm	6	60	

DE Flachrundzange, gerade EN Long nose pliers FR Pince à bec long demi-rond ES Alicates de punta larga HR Klijesta izdužena, ravna HU Rádiós fogók RO Cleste cu varf lung BG Клещи угължени прави



CrV HRC 58-62 DIN 5745 180° ERGO GRIP

HT1P016	160 mm	6	60	
HT1P020	200 mm	6	60	

DE Halbrunde Zangen, gebogen EN Half-round bent pliers FR Pince à bec long demi-rond coudé ES Alicates de punta semirredonda acodado HR Klijesta izdužena, zakrivljena HU Hajlított rádiós fogók RO Cleste cu varf lung, curb BG Клещи "плоскоустни" угължени извити



CrV HRC 58-62 DIN 5745 180° ERGO GRIP

HT1P022	160 mm	6	60	
HT1P024	200 mm	6	60	

DE Halbrunde Zangen, gebogen EN Flat nose pliers FR Pince à bec long plat ES Alicates plano HR Pļjosnata klijesta HU Lapos hegyű rádiós fogók RO Cleste cu varf lung, plat BG Клещи "плоскоустни" прави



CrV HRC 58-62 DIN 5745 180° ERGO GRIP

HT1P026	160 mm	6	60	

DE Präzisions-Kombinationszange EN Precision universal pliers FR Pince universelle de précision ES Alicates de precisión universal HR Precizna univerzalna klijesta HU Precíziós univerzális fogók RO Cleste universal de precizie BG Прецизни комбинирани клещи



HRC 50-55 180° ERGO GRIP

HT1P050	125 mm	6	72	

DE Präzisions-Seitenschneider EN Precision diagonal cutting plier FR Pince universelle de précision ES Alicates de corte diagonal de precisión HR Precizna bočna klijesta HU Precíziós oldalsípő fogó RO Cleste de taiere diagonala de precizie BG Прецизни клещи резачки



HRC 50-55 180° ERGO GRIP

HT1P052	115 mm	12	120	

DE Präzisions-Flachrundzange, gerade EN Precision long nose pliers FR Pince à bec long demi-rond de précision ES Alicates de punta larga de precisión HR Precizna izdužena klijesta, ravna HU Precíziós rádiós fogók RO Cleste cu varf lung de precizie BG Прецизни универсални клещи удължени



HRC 50-55 180° ERGO GRIP

HT1P054	130 mm	12	120	

DE Halbrunde Präzisionszange, gebogen EN Precision bent pliers FR Pince à bec demi-rond de précision ES Alicates de punta semirredonda de precisión HR Precizna izdužena klijesta, zakrivljena HU Precíziós hajlított rádiós fogó RO Cleste cu varf lung, curbat, de precizie BG Прецизни универсални клещи узвити



HRC 50-55
180°
ERGO GRIP

HT1P056	125 mm	6	72

DE Präzisions-Kombinationszange EN Precision end cutting pliers FR Pince coupante devant de précision ES Alicates de corte delantero de precisión HR Precizna čeona klijesta HU Precíziós homlokcsípő fogók RO Cleste de precizie cu taietura frontala BG Прецизни клещи керпеден



HRC 50-55
180°
ERGO GRIP

HT1P058	115 mm	6	72

DE Allzweckwerkzeuge EN Multipurpose tool FR Pince multifonction ES Herramienta multifunción HR Višenamjenski alat HU Multi-funkciós szerszám RO Scule multifunctionale BG Мултифункционален сгъваем нож



2CR13
10in1

HT1P070	110 mm	12	48

DE Seegerringzange – innen, gerade EN Ring circlip pliers, internal straight FR Pince à circlips interne droite ES Alicates circlips interno recto HR Klijesta za pričvršne prstenove – unutarnja, ravna HU Zégergyűrű fogó, belső egyenes RO Cleste cu falci rotunde, drept, intern BG Зегер клещи вътрешни прави



CrV

HT1P145	150 mm	12-25 mm	6 60
HT1P141	180 mm	19-60 mm	6 60

DE Seegerringzange – innen, gekrümmt EN Ring circlip pliers, internal bent FR Pince à circlips interne droite ES Alicates circlips interno acodado HR Klijesta za pričvršne prstenove – unutarnja, ukošena HU Zégergyűrű fogó, belső hajlított RO Cleste cu falci rotunde, indoit, intern BG Зегер клещи вътрешни закривени



CrV

HT1P147	150 mm	12-25 mm	10 60
HT1P143	180 mm	19-60 mm	6 60

DE Seegerringzange – außen, gerade EN Ring circlip pliers, external straight FR Pince à circlips externe droite ES Alicates circlips externo recto HR Klijesta za pričvršne prstenove – vanjska, ravna HU Zégergyűrű fogó, külső egyenes RO Cleste cu falci rotunde, drept, extern BG Зегер клещи външни прави



CrV

HT1P146	150 mm	10-25 mm	6 60
HT1P142	180 mm	19-60 mm	6 60

DE Seegerringzange – außen, gekrümmt EN Ring circlip pliers, external bent FR Pince à circlips externe droite ES Alicates circlips externo acodado HR Klijesta za pričvršne prstenove – vanjska, ukošena HU Zégergyűrű fogó, külső hajlított RO Cleste cu falci rotunde, indoit, extern BG Зегер клещи външни закривени

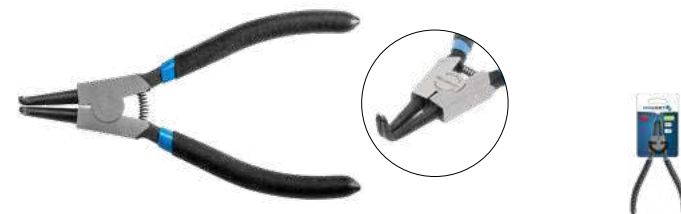

CrV

HT1P148	150 mm	10-25 mm	6 60
HT1P144	180 mm	19-60 mm	6 60

DE Schweißzange, Typ „W“ EN Welding pliers type W FR Pincés à souder, type „W“ ES Alicates de soldadura, tipo „W“ HR Klijesta za zavarivanje, tip „V“ HU Hegesztő fogó – „W” típus RO Cleste pentru sudura tip „W“ BG Клещи чирази заваръчни тип U-form



230 mm W

HT1P385	230 mm / 9"	10	40

DE Schweißzange, Typ „C“ EN Welding pliers type C FR Pincès à souder, type „C“ ES Alicates de soldadura, tipo „C“ HR Klješta za zavarivanje, tip „C“ HU Hegesztő fogó – „C” típus RO Cleste pentru sudura tip „C“ BG Клещи чираци заваръчни тип C-form



280 mm C

HT1P386	280 mm / 11"	10	40

DE Schweißzange flach EN Flat welding pliers FR Pincès à souder plates ES Alicates de soldadura plana HR Klješta za zavarivanje HU Hegesztő fogók – lapos pófával RO Cleste pentru sudura, plata BG Клещи чираци заваръчни широки челюсти



250 mm FLAT

HT1P387	240 mm	10	40

DE Gewindeschneidwerkzeuge EN Tap and die set FR Jeux d'outils de filetage ES Juegos de herramientas roscadoras HR Nit rezači HU Menetfúró vagy menetvágó szerszám RO Scule de tarodat sau filetat BG Резачки конци

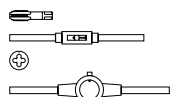

M3 × 0.5
M4 × 0.7
M5 × 0.8
M6 × 1.0
M7 × 1.0
M8 × 1.25
M10 × 1.5
M12 × 1.75
NPT27 × 1/8



×20 HSS M3-M12

HT3B580	1	2

DE Gewindeschneidwerkzeuge EN Tap and die set FR Jeux d'outils de filetage ES Juegos de herramientas roscadoras HR Nit rezači HU Menetfúró vagy menetvágó szerszám RO Scule de tarodat sau filetat BG Резачки конци

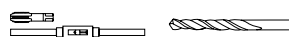

M3 × 0.5 2.5 mm
M4 × 0.7 3.3 mm
M5 × 0.8 4.2 mm
M6 × 1.0 5.0 mm
M8 × 1.25 6.8 mm
M10 × 1.5 8.5 mm
M12 × 1.75 10.2 mm



×15 HSS M3-M12

HT3B581	1	2

DE Gewindeschneidwerkzeuge EN Tap and die set FR Jeux d'outils de filetage ES Juegos de herramientas roscadoras HR Nit rezači HU Menetfúró vagy menetvágó szerszám RO Scule de tarodat sau filetat BG Резачки конци



M3 × 0.5/1 M6 × 1.0/3
M3 × 0.5/2 M8 × 1.25/1
M3 × 0.5/3 M8 × 1.25/2
M4 × 0.7/1 M8 × 1.25/3
M4 × 0.7/2 M10 × 1.5/1
M4 × 0.7/3 M10 × 1.5/2
M5 × 0.8/1 M10 × 1.5/3
M5 × 0.8/2 M12 × 1.75/1
M5 × 0.8/3 M12 × 1.75/2
M6 × 1.0/1 M12 × 1.75/3
M6 × 1.0/2

M3 × 0.5
M4 × 0.7
M5 × 0.8
M6 × 1.0
M8 × 1.25
M10 × 1.5
M12 × 1.75

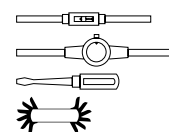

×32 HSS M3-M12

HT3B582	1	2

DE Drehschraubstock EN Rotary Vice FR Étau pivotant ES Tornillo de banco giratorio HR Okretni škripac HU Satu RO Menghină BG Менгеме с въртяща се основа



360° 125 mm HARDENED JAWS HEAVY DUTY SG IRON

HT3B611	125 mm	1	2
HT3B612	150 mm	1	1
HT3B613	200 mm	1	1

DE Modellieren Schraubstock EN Modeling vise FR Étau de modelage ES Tornillo de banco de modelado HR Viska za modeliranje RO Menghină de modelare HU Modellező satu BG Менгеме за моделиране



SG IRON 60 mm HARDENED JAWS

HT3B609	60 mm	50	20